

NORTON

®

SAINT-GOBAIN



STEP-BY-STEP BUILD GUIDE

nortonabrasives.com

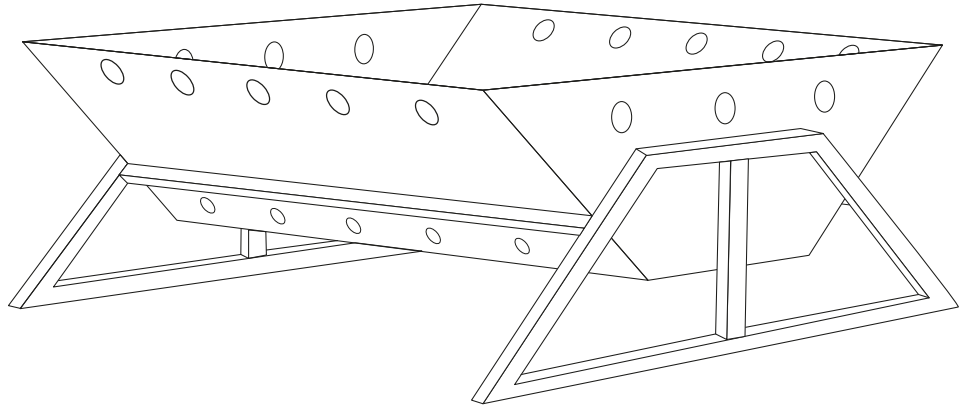

YOU WILL NEED:

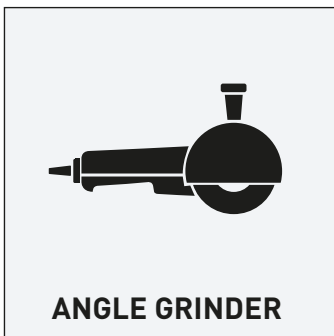
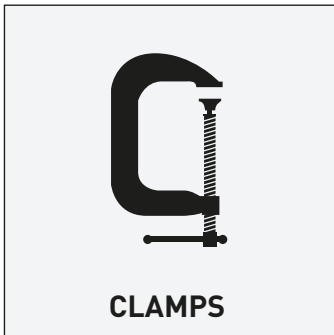

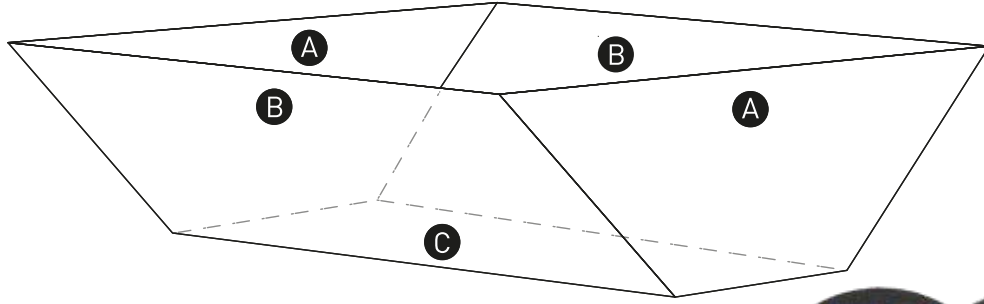

NORTON QUANTUM3
1.3mm CUTTING DISC

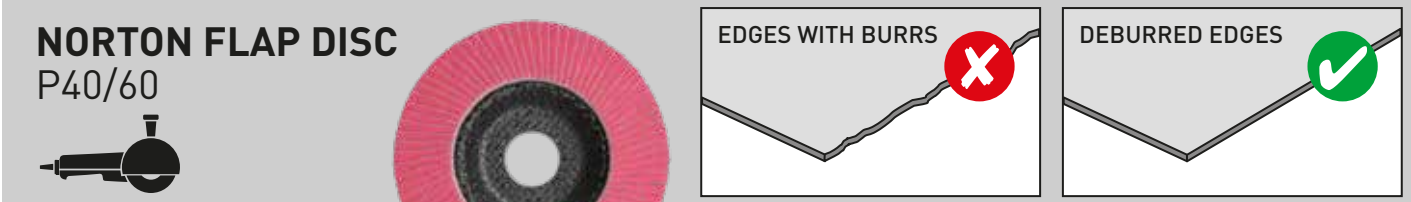
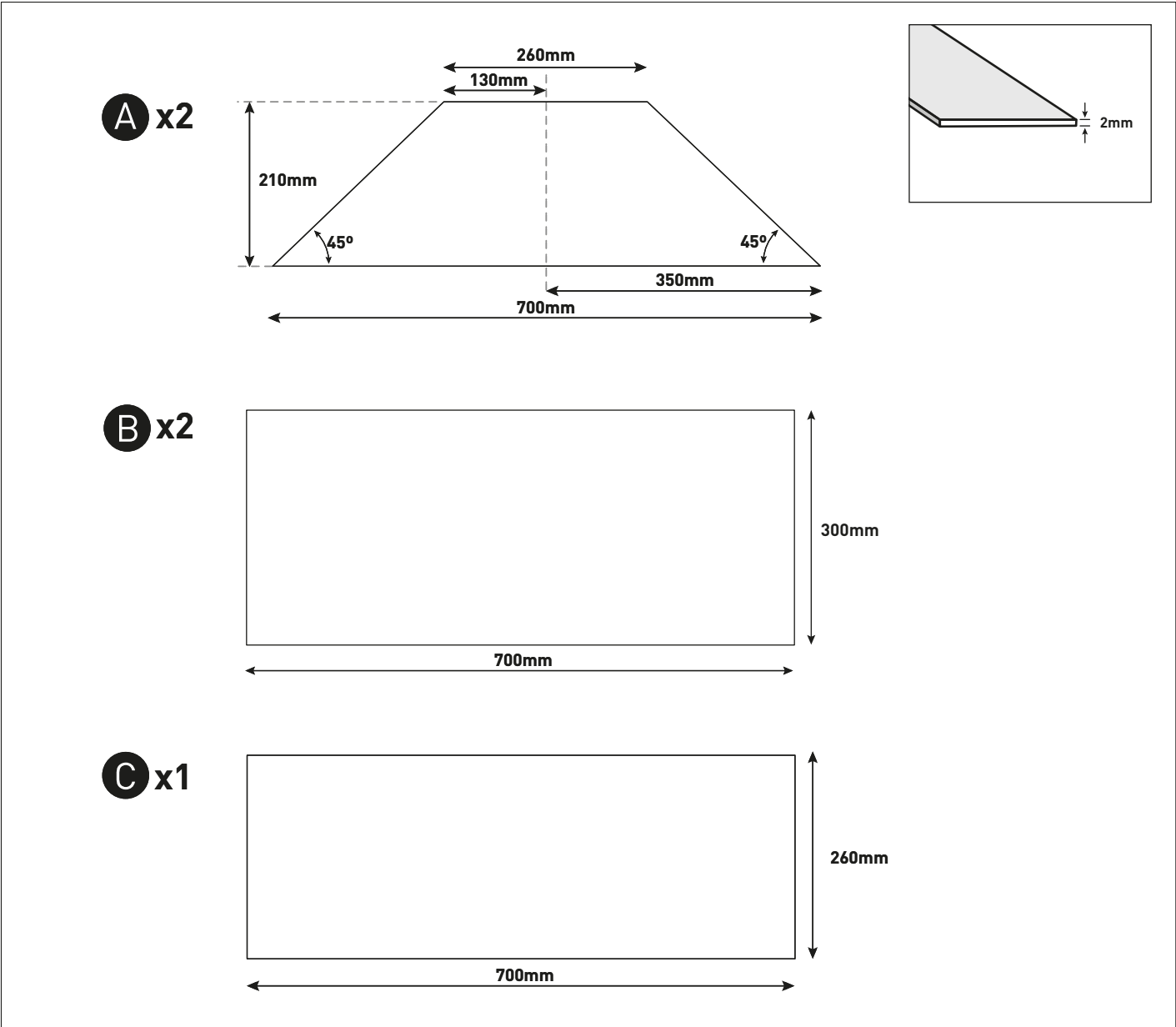
A x2

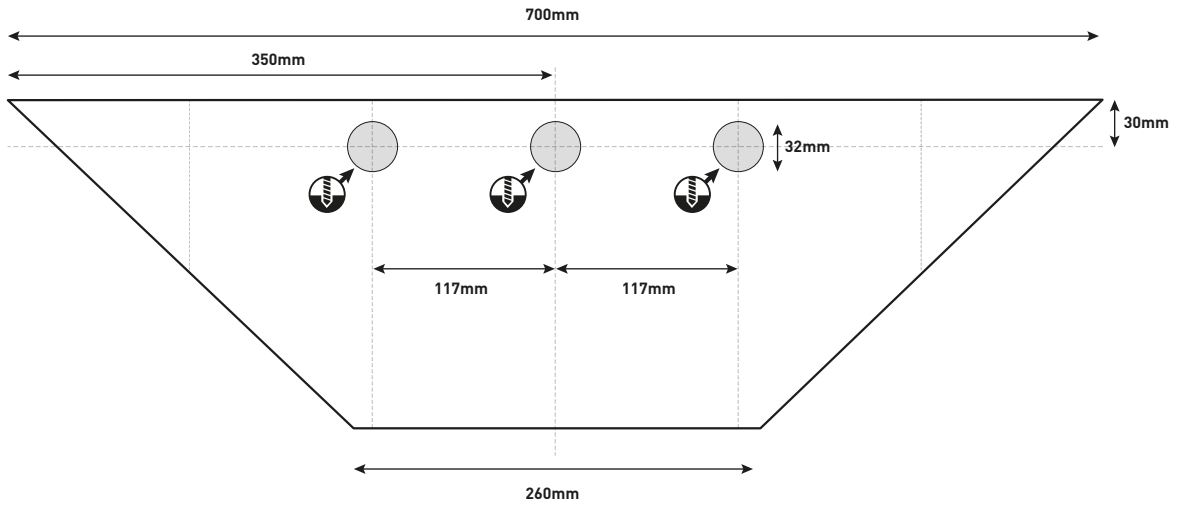
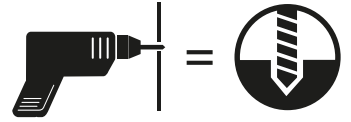

B x2

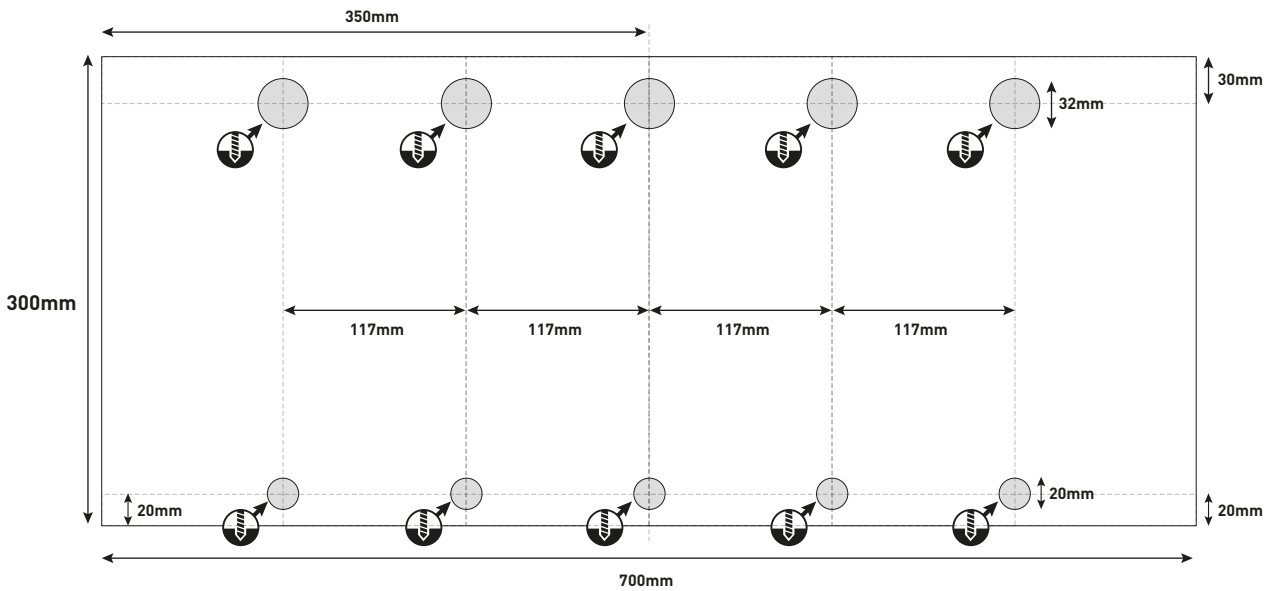

- 1) BLAZE RAPID STRIP DISC
- 2) VORTEX RAPID BLEND

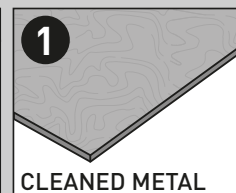
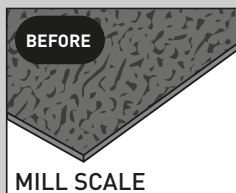

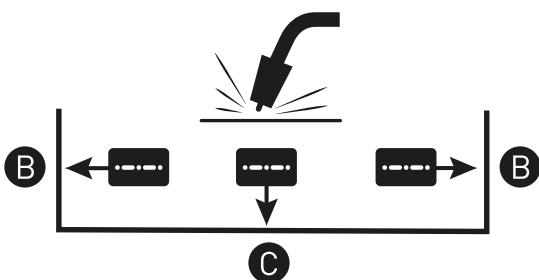
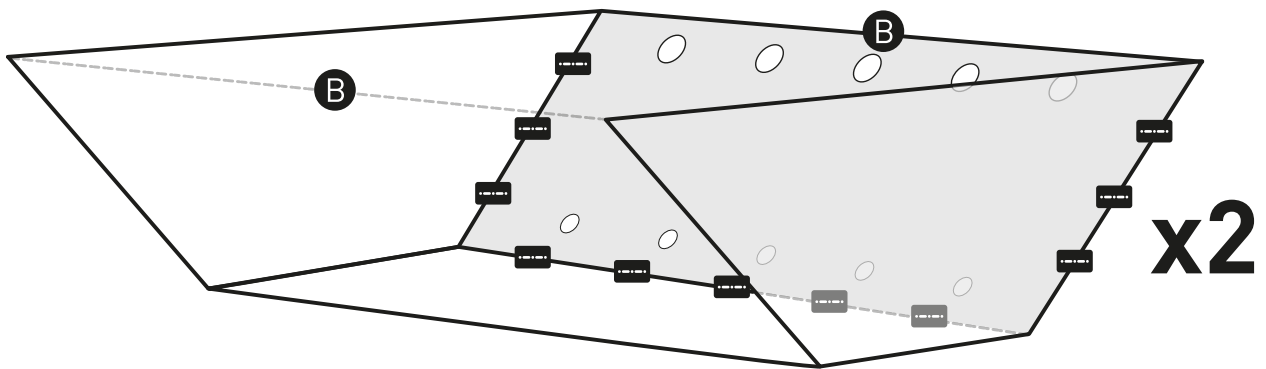
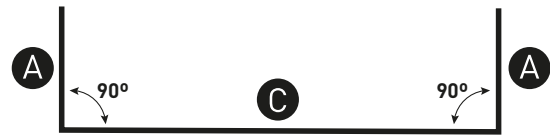
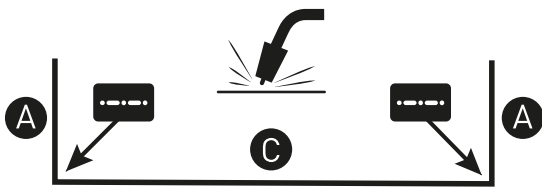
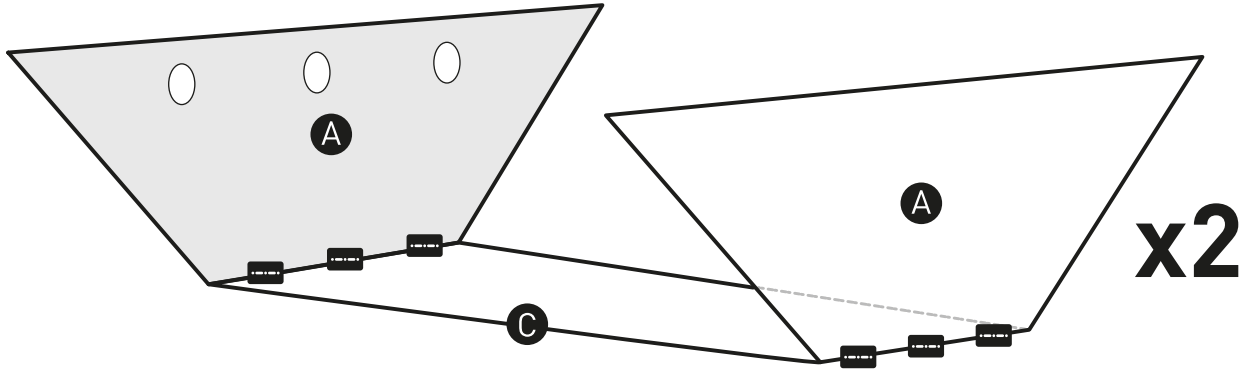

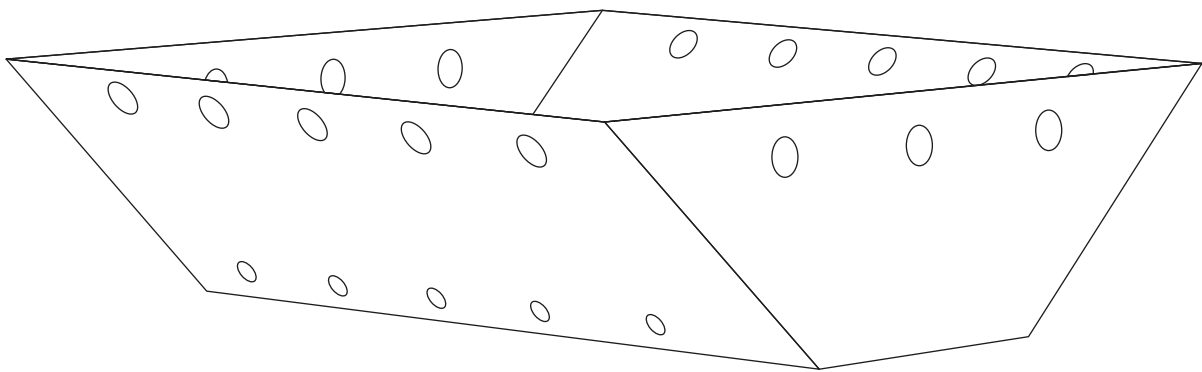
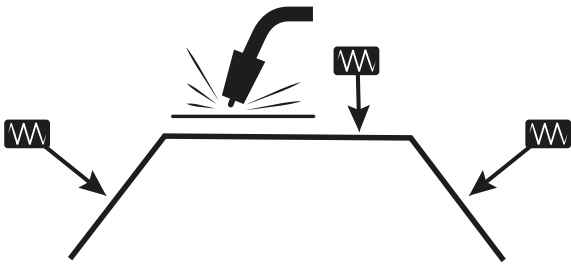
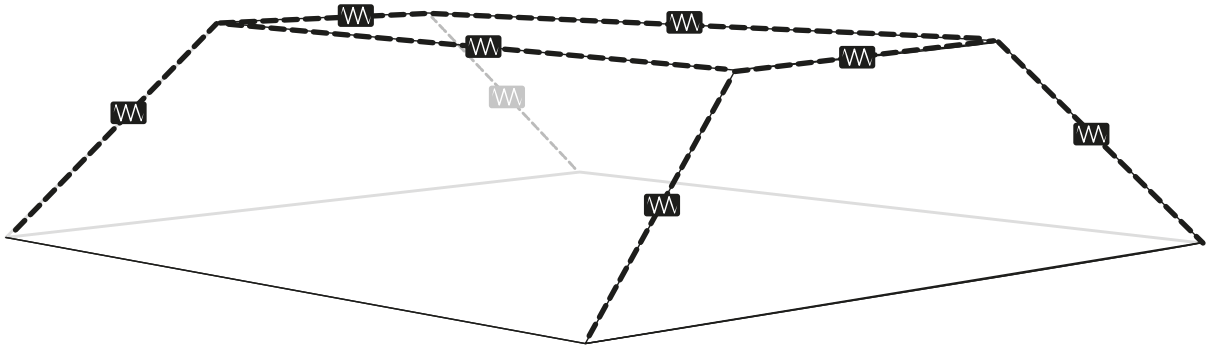

NORTON FLAP DISC
P60

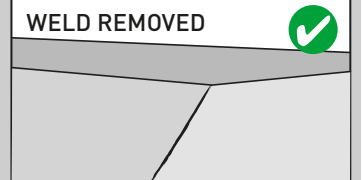
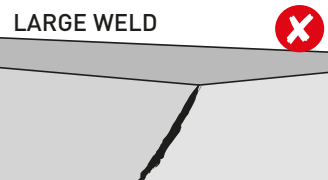

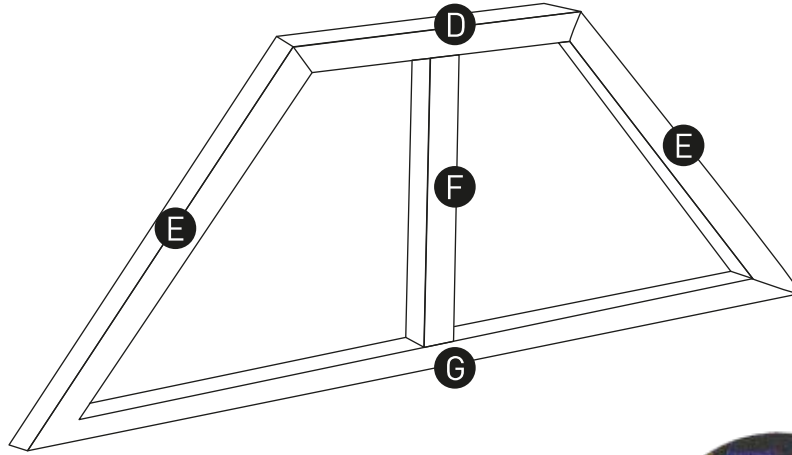

NORTON QUANTUM3
1.3mm CUTTING DISC

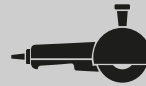

D x2

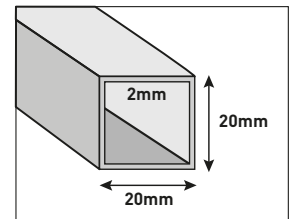
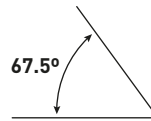
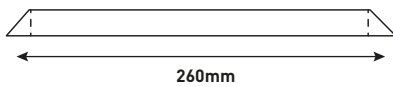

E x4

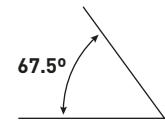
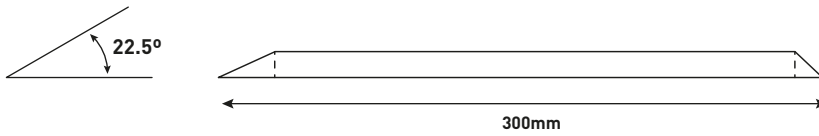

F x2

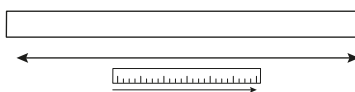

G x2

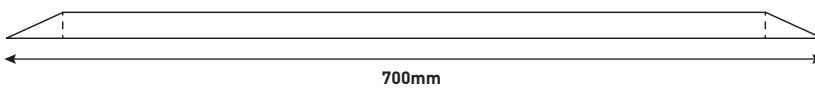

NORTON FLAP DISC
P40/60

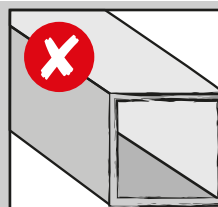

BURRS

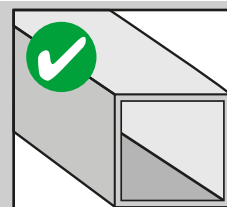

SMOOTH EDGES

- 1) BLAZE RAPID STRIP DISC
- 2) VORTEX RAPID BLEND

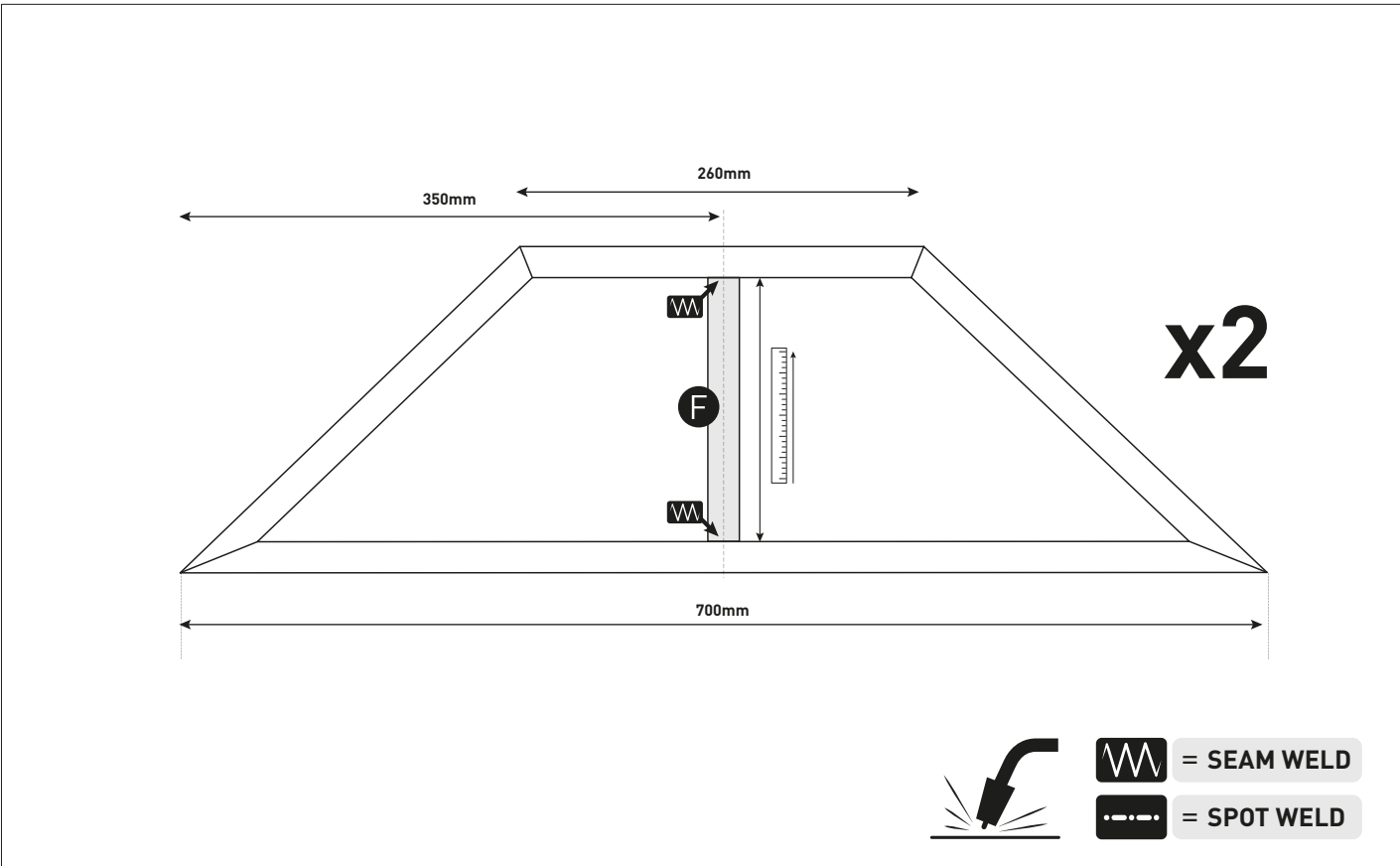
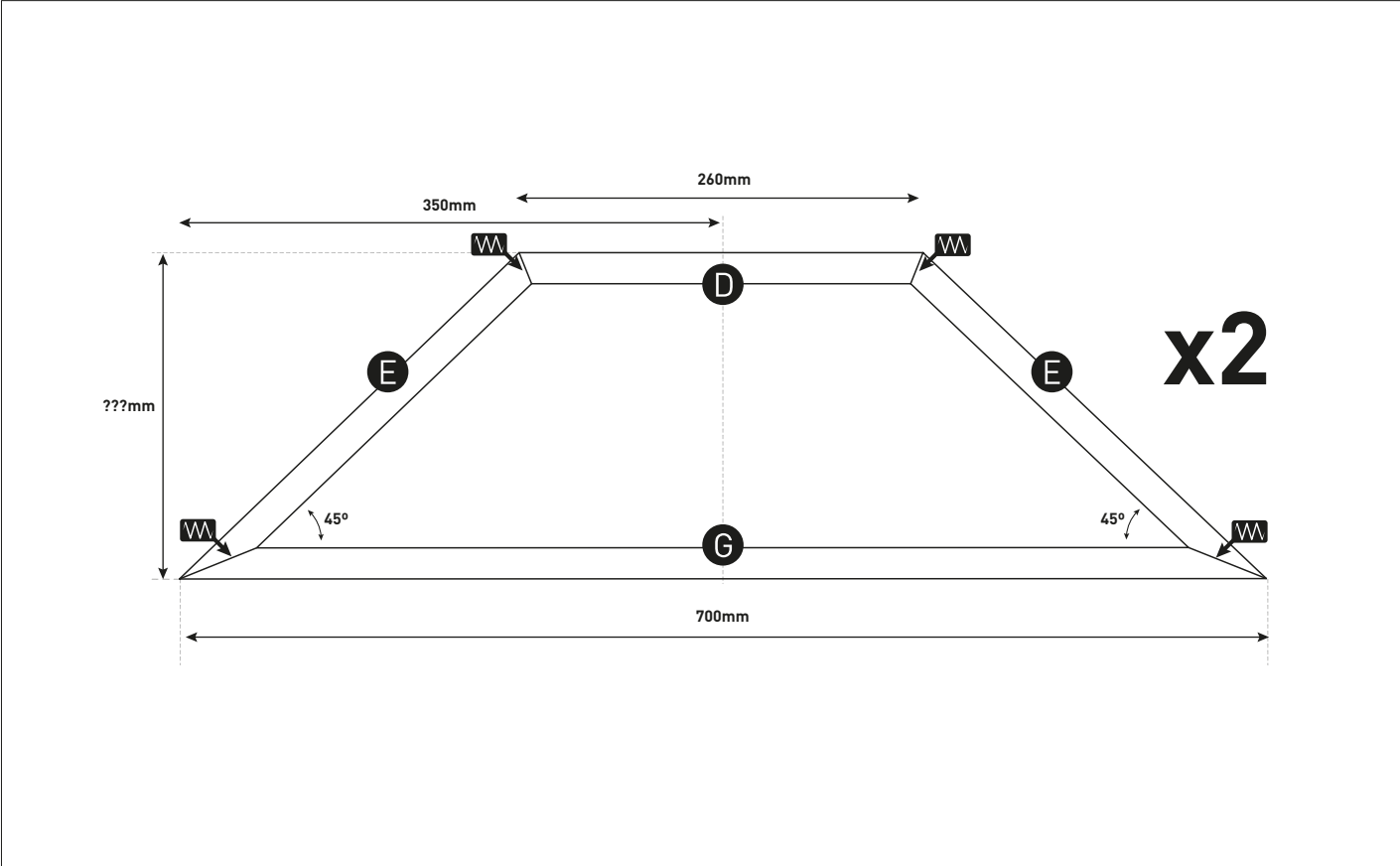
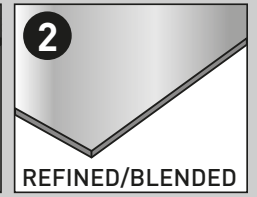
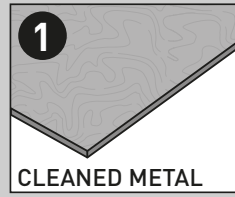
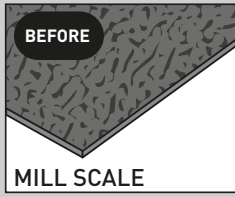
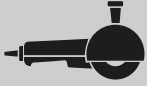

**NORTON FIBRE DISC
P60**

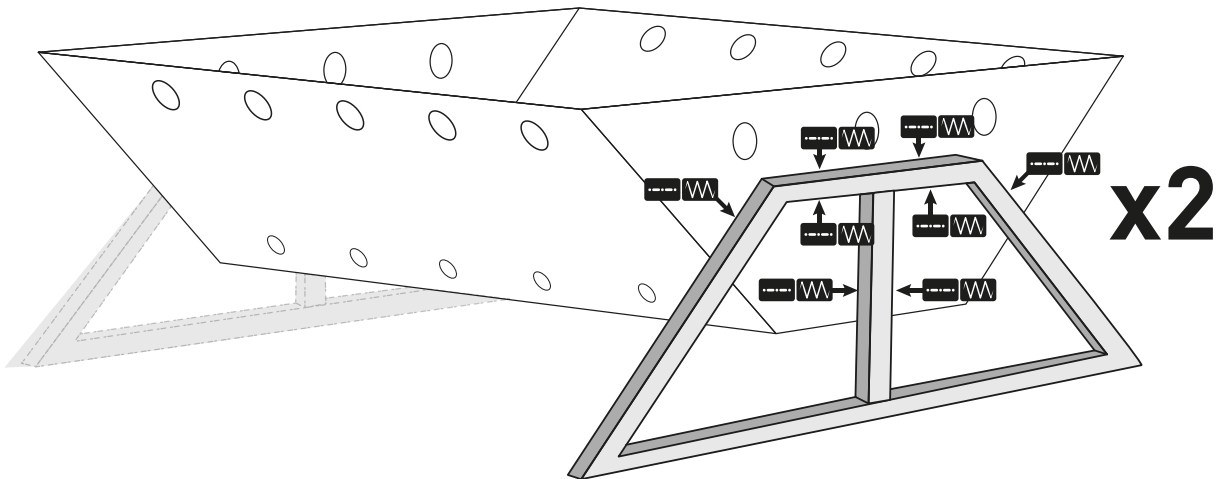
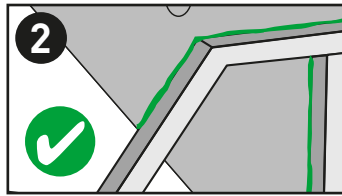
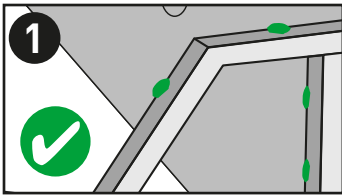
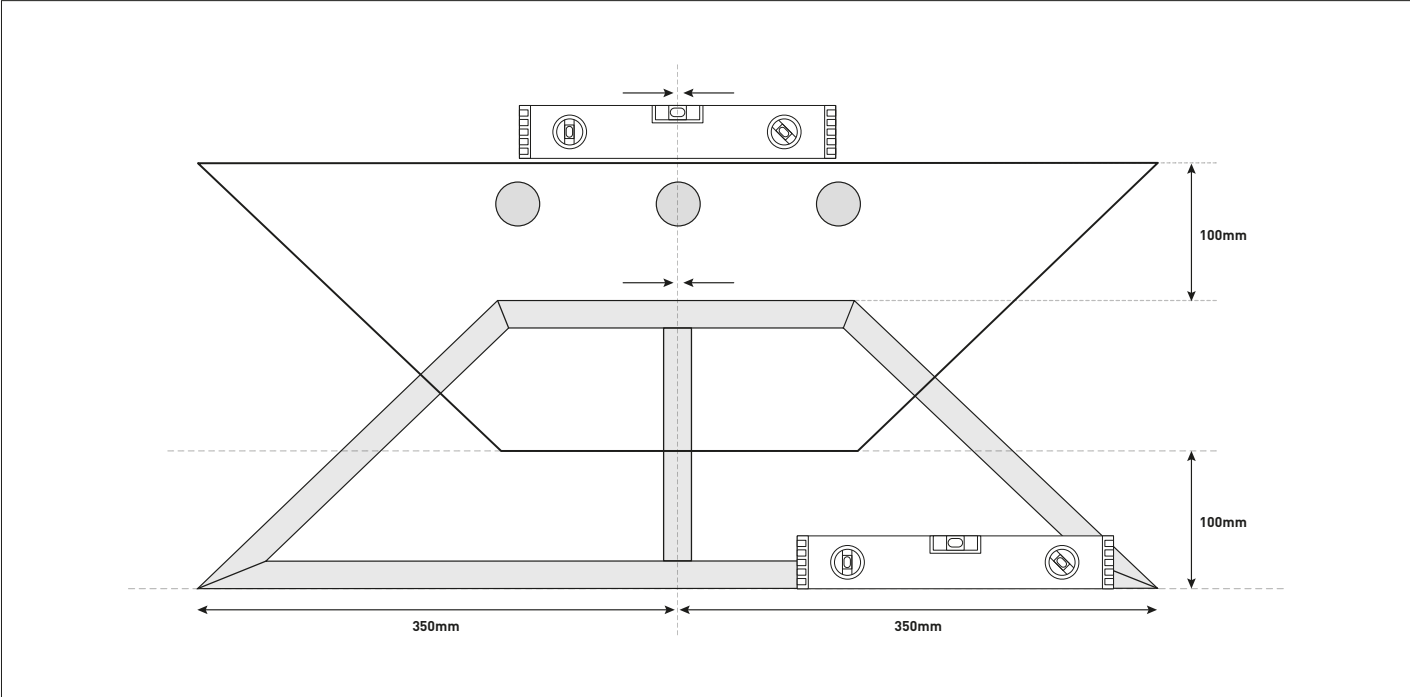
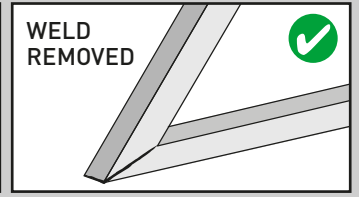
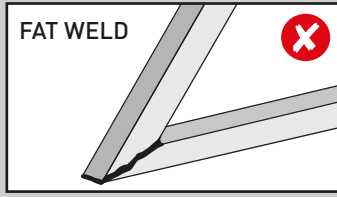
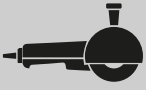

**NORTON FIBRE DISC
P60**

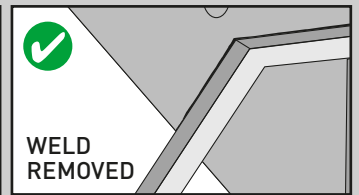
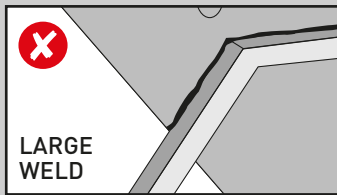
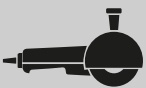

NORTON QUANTUM3
1.3mm CUTTING DISC



H x2

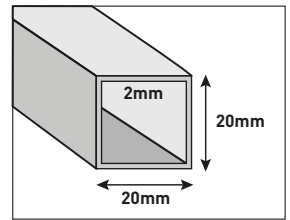
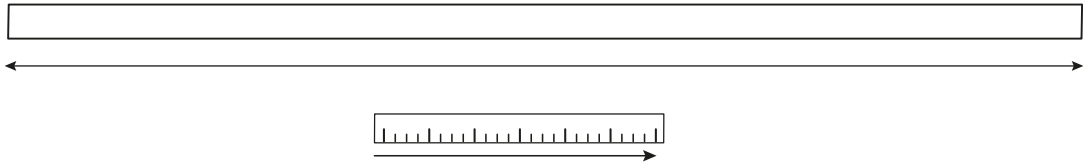

H x2

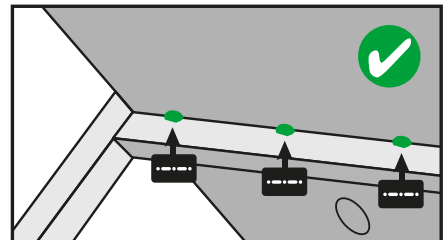
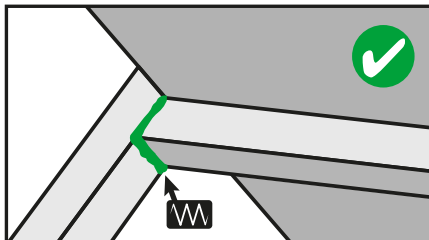
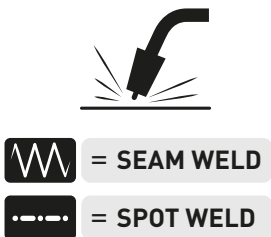
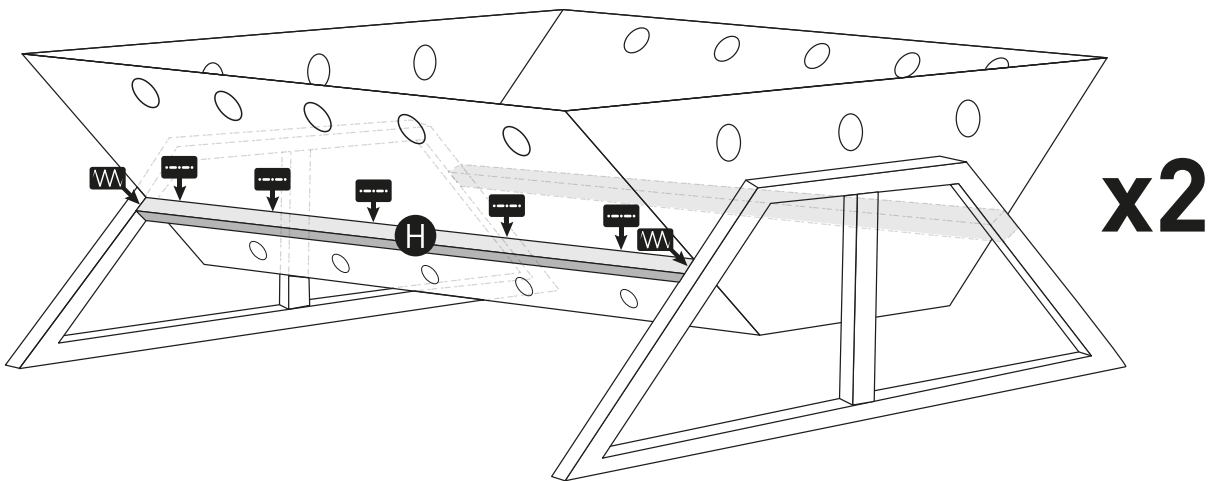

NORTON QUANTUM3
1.3mm CUTTING DISC



J x1

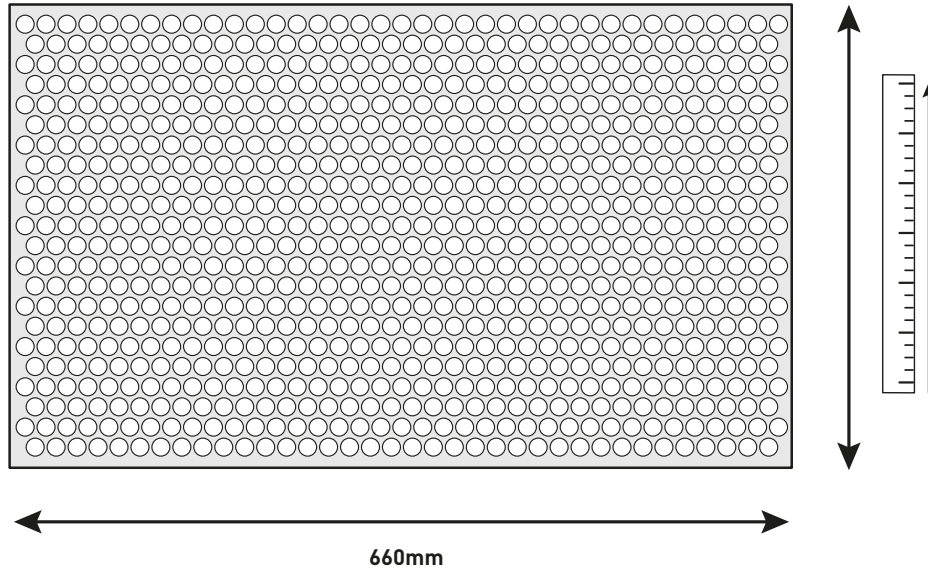

J

