

CM 351

OPERATING INSTRUCTIONS

Translation of the original instructions



clipper®



CE Declaration of conformity

The undersigned manufacturer:

**SAINT - GOBAIN ABRASIVES S.A.
190, BD J.F. KENNEDY
L- 4930 BASCHARAGE**

Declares that this product:

Masonry Saws: **CM 351 115V UK**
CM 351 230V

Code: **70184630321**
70184630312

is in conformity with the following Directives:

- **"MACHINES" 2006/42/CE**
- **"LOW VOLTAGE" 2014/35/UE**
- **"ÉLECTROMAGNÉTIQUE COMPATIBILITÉ" 2014/30/UE**
- **"NOISE" 2000/14/CE**

and European standard:

- **EN 12418 – Masonry and stone cutting-off machines – Safety**

Valid for machines as of serial number:70100000

Storage site for the technical documents :

Saint-Gobain Abrasives 190, Bd. J. F. Kennedy 4930 BASCHARAGE, LUXEMBOURG

This declaration of conformity loses its validity when the product is converted or modified without agreement.

Bascharage, Luxembourg, 01.10.2020

François Chianese, executive officer.

CM 351

OPERATING INSTRUCTIONS

TABLE OF CONTENTS

1	BASIC SAFETY INSTRUCTIONS	6
1.1	<i>Symbols</i>	6
1.2	<i>Machine plate</i>	7
1.3	<i>Safety instructions for particular operating phases</i>	7
2	MACHINES DESCRIPTION	8
2.1	<i>Short description</i>	8
2.2	<i>Purpose of use</i>	8
2.3	<i>Layout</i>	8
2.4	<i>Technical data</i>	10
2.5	<i>Statement regarding the vibration emission</i>	11
2.6	<i>Statement regarding noise emission</i>	12
3	ASSEMBLY AND COMMISSIONING	13
3.1	<i>Feet assembly</i>	13
3.2	<i>Tool assembly</i>	13
3.3	<i>Electrical connections</i>	13
3.4	<i>Water cooling system</i>	14
3.5	<i>Starting the machine</i>	14
4	TRANSPORT AND STORING	15
4.1	<i>Securing for transport</i>	15
4.2	<i>Transport procedure</i>	15
4.3	<i>Storing of the machine</i>	15
5	OPERATING THE MACHINE	16
5.1	<i>Installation</i>	16
5.2	<i>Cutting methods</i>	16
6	MAINTENANCE AND SERVICE	19
7	BREAKDOWN – CAUSES AND CURES	20
7.1	<i>Breakdown-finding procedures</i>	20
7.2	<i>Trouble-shooting guide</i>	20
7.3	<i>Circuit diagram 230V</i>	21
7.4	<i>Customer service</i>	23

1 BASIC SAFETY INSTRUCTIONS

The CM 41 is exclusively designed for the cutting of construction products, with NORTON diamond blades, mainly on construction sites.

Uses other than the manufacturer's instructions shall be considered as contravening the regulations. The manufacturer shall not be held responsible for any resulting damage. Any risk shall be borne entirely by the user. Observing the operating instructions and compliance with inspection and servicing requirements shall also be considered as included under use in accordance with the regulations.

1.1 Symbols

Important warnings and pieces of advice are indicated on the machine using symbols. The following symbols are used on the machine:



Read operator's instructions



Ear protection must be worn



Hand protection must be worn



Eye protection shall be worn

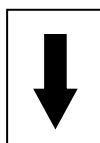

Rotation direction of the blade



Danger: risk of cut

1.2 Machine plate

Important data can be found on the following plate located on the machine:

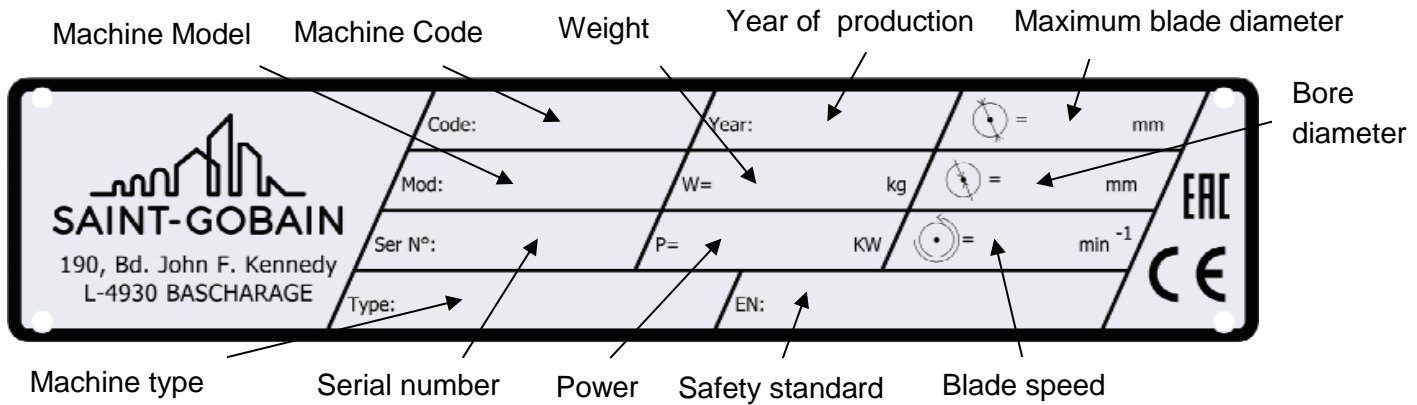

1.3 Safety instructions for particular operating phases

Before commencing work

- Before commencing work, make yourself familiar with the working environment at the place of use. The working environment includes: obstacles in the area of work and manoeuvre, the firmness of the floor, necessary protection at the site relating to public thoroughfares and the availability of help in the event of accidents.
- Check for correct mounting of the blade regularly.
- Immediately remove damaged or badly worn blades, as they endanger the operator whilst rotating.
- Only fit NORTON diamond blades to the machine! The use of other tools can damage the machine!
- Please wear safety goggles and a dust mask when cutting dry to minimize the effects of dust.
- For security reasons, never leave the machine unattended, untied or unlocked.

While the motor running

- Do not move the machine whilst the blade is running idle.
- Always cut with the blade guard in position.
- Apply cooling water continuously whilst cutting and in good time!

2 MACHINES DESCRIPTION

Any modification, which could lead to a change in the original characteristics of the machine, may be done only by Saint-Gobain Abrasives who shall confirm that the machine is still in conformity with the safety regulations.

2.1 Short description

The CM 351 Masonry saw is designed for durability and high performance for onsite wet and dry cutting operations of a wide range of masonry, refractory and natural stone products. It can be used on construction or industrial site. Combined with NORTON diamond blades, it offers high performance and quality cuts of materials used in construction. The machine and its component parts are assembled to high standards assuring long life and minimum maintenance.

2.2 Purpose of use

The CM 351 is designed for wet and dry cutting of a large range of building and refractory materials, or tiles. **It is not designed for cutting wood or metals.**

2.3 Layout

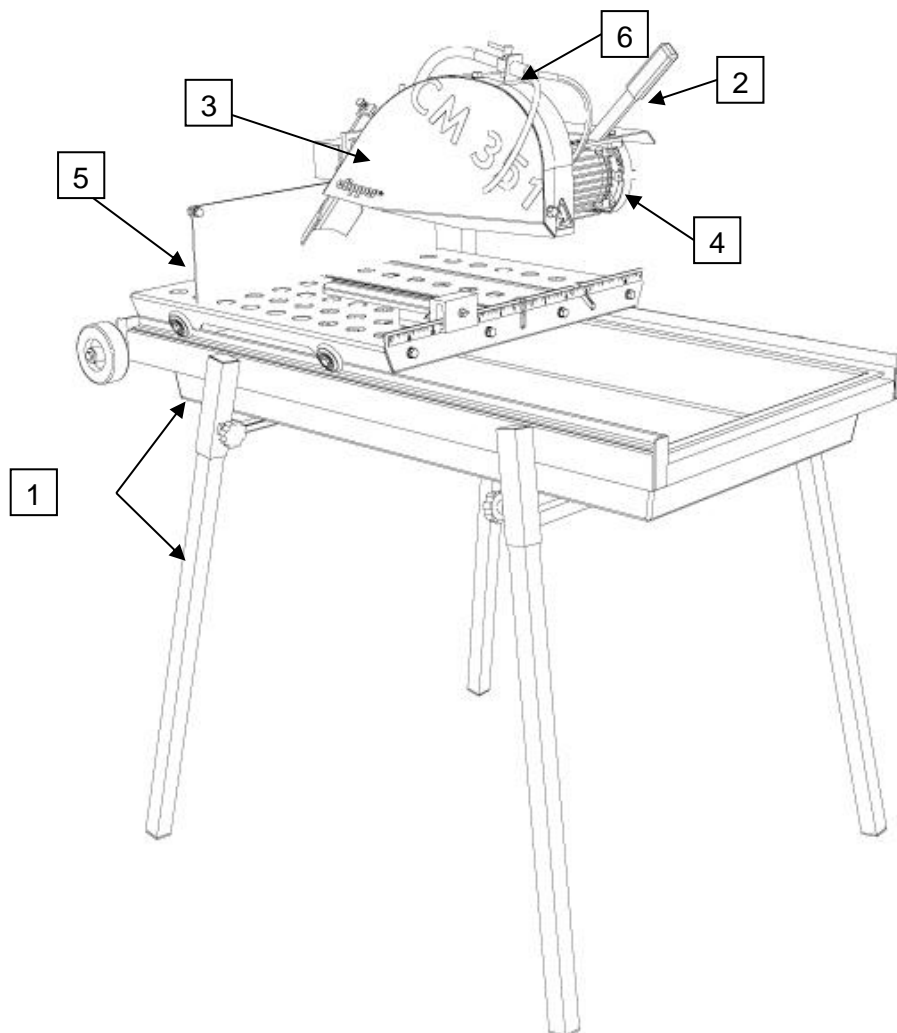

Frame and feet (1)

The frame is made of a jig-welded reinforced steel construction to ensure perfect rigidity. The machine is mounted on four removable legs 4 locked with screws and equipped of wheels for transportation.

Cutting head (2)

The pivot is jig-machined with precision. A spring system brings the blade automatically in the up position. The cutting head can be tilted to **45°** for bevels cuts. Straight-through cutting can be made by means of a locking device.

Blade guard (3)

Jig-welded steel construction with 350mm-diameter blade capacity, which offers maximum operator protection and increased visibility of the work piece.

Incorporated in the blade guard is an outer metal cover, which can be easily removed to allow easy access to shaft for inspection and blade replacement when motor is switched off, while fully protecting the blade when in operation. The rotation of the disc is indicated by an arrow on the sidewall of the blade guard.

Electric motor and switch (4)

Electric motor **2.2kW 230V or 2.0kW 115V** with an overload protection. Low voltage trigger (NVR) built in the switch prevents the motor to restart for example after a power cut. Thermal overload tripping can occur for two reasons:

- tripping under light load if connection is incorrect
- tripping under heavy load if motor has been overloaded.

The ON-OFF switch also serves as emergency stop.

Conveyor cart (5)

Steel welded construction with a stop material. The guide system of the conveyor cart permits precise cuts. The guide-a-cut and the large surface of the conveyor cart provide precise positioning of the material.

Water cooling system (6)

The coolant system comprises:

- A powerful, submersible electric water pump.
- Plastic suction pipe delivering the water from the water pan to the cutting head.
- A water tray placed on two adjustable supports.
- A water-tap, fitted to the blade guard, permitting controlled water flow.
- Two water nozzles located on the blade guard ensure adequate flow of water to both sides of the cutting blade.
- A water splash guard, fixed to head axle restricts water spray and minimises water loss.

Attention: The water pump must never run without water.

2.4 Technical data

Machines	CM 351 2.2KW-1-230V	CM 351 2.0KW-1-115V
Motor	2,2 kW 230V 2800tr. min ⁻¹ With thermal overload protection	2,0 kW 115V 2700tr. min ⁻¹ With thermal overload protection
Electric motor protection	IP54	
Max. blade diameter	350 mm	
Bore	25,4 mm	
Rotation speed of the blade	2800 min ⁻¹	2700 min ⁻¹
Max. cutting depth	110 mm (without reversing the material)	
Flange diameter	90 mm	
Sound pressure level	73 dB (A) (ISO EN 11201)	
Sound energy level	87 dB (A) (ISO EN 3744)	
Max. cutting length	700mm	
Conveyor cart dimensions (L x l)	600 x 600 mm	
Machines dimensions with feet (L x l x H)	1190x830x1325 mm	
Machines dimensions without feet (L x l x H)	1190x745x655 mm	
Weight (without water and blade)	69 kg	
Weight ready for use (with water and blade)	99 kg	

2.5 Statement regarding the vibration emission

Declared value of vibration emission following **EN 12096**.

Machine Model / code	Measured value of vibration emission at m/s ²	Uncertainty K m/s ²	Tool used Model / code
CM 351 115V UK 70184630321	2.2	0.5	Clipper ALFA
CM 351 230V 70184630312			

- The vibration value is lower and does not exceed 2.5 m / s.
- Values determined using the procedure described in the standard **EN 12418**.
- The measurements are made with new machines. Actual values may vary with site conditions, in terms of:
 - Materials worked
 - Wear Machine
 - Lack of maintenance
 - Inappropriate tool for application
 - Tool in poor condition
 - Unskilled operator
 - Etc...
- The exposure time to vibration is based on the performance of work (related to the adequacy Machine / Tool / worked material / operator)

When evaluating risks due to hand-arm vibration, you need to take into account effective usage at rated power of machine during a full day of work; quite often you will realise that effective utilisation time represents around 50% of overall duration of work. You have to consider, of course, breaks, water feeding, preparation of work, time to move the machine, disk mounting...

2.6 Statement regarding noise emission

Declared value of noise emission following **EN ISO 11201** and **NF EN ISO 3744**.

Machine Model / code	Sound Pressure level L_{Peq} EN ISO 11201	Uncertainty K (Sound Pressure level L_{Peq} EN ISO 11201)	Sound power level L_{Weq} NF EN ISO 3744	Uncertainty K (Sound power level L_{Weq} NF EN ISO 3744)
CM 351 115V UK 70184630321	73 dB(A)	2.5 dB(A)	87 dB(A)	4 dB(A)
CM 351 230V 70184630312				

- Values determined using the procedure described in the standard **EN 12418**.
- The measurements are made with new machines. Actual values may vary with site conditions, in terms of:
 - Wear Machine
 - Lack of maintenance
 - Inappropriate tool for application
 - Tool in poor condition
 - Unskilled operator
 - Etc...
- Measured values relate to an operator in normal use, as described in the manual position.

3 ASSEMBLY AND COMMISSIONING

The machine is delivered fully equipped and ready to use. Before using the machine the first time, please follow the following instructions.

3.1 Feet assembly

The machine is delivered with the feet dismounted.

- Mount the feet and tighten them with the locking screws.

3.2 Tool assembly

Only **NORTON** blades with a maximum diameter of **350mm** can be used. All tools used must be selected with regard to their maximum permitted cutting speed for the machine's maximum permitted rotation speed.

- Switch off the machine and unplug it from the electrical supply before to mount or change the blade.
- Loosen the screws of the blade guard, disconnect the water hose on the left side and open the removable part of the blade guard.
- Loosen the hexagonal nut (left threaded) of the motor blade shaft which holds the removable outer flange, and remove the nut and the removable flange.
- Make sure the flanges and the blade shaft are cleaned and inspect for wear.
- Mount the blade on arbour ensuring that direction of rotation is correct with the arrow on the blade guard.
- Replace the removable flange
- Tighten the hexagonal nut with the spanner supplied for this purpose.
- Close the blade guard; reconnect the water hose and tighten the screws of the blade guard.

ATTENTION: The blade bore must correspond exactly to the diameter of the blade shaft. Cracked or damaged bore is dangerous for the operator and for the machine.

3.3 Electrical connections

Check that:

- The voltage/phase supply corresponds to the information indicated on the machine.
- Available power supply must have ground connection in conformity with safety regulations.
- The connecting cables should have at least a 2.5mm²-section per phase.

3.4 *Water cooling system*

- Fill the water tray with clean water (to approximately 3cm from top) to ensure that bottom of the pump is fully immersed in its decanting basket).
- The blade must be well cooled on both sides. You can adjust the water flow by the means of the water tap. Insufficient water supply may result in premature failure of the diamond blade. Make sure the water hose and nozzles are not clogged.
- The water pump must never run without water. Always make sure that there is enough water in the water tray above the aspiration of the water pump.
- In case of frost, empty the water cooling system from its water.

3.5 *Starting the machine*

To start the machine:

- Open the cover on the front side of the switch and press the green button.

To stop the machine:

- Press the red button or directly the emergency stop on the cover of the switch.

The switch activates or deactivates both motor and water pump.

4 TRANSPORT AND STORING

4.1 *Securing for transport*

Before transporting the machine, please follow the following instructions:

- Always dismount the blade.
- Empty the water tray and remove it.
- Tighten the screws of the two water tray supports.
- Remove also the conveyor cart to prevent any danger.
- Loosen the screws of the feet and take them off.

The Blade, the water tray, the conveyor cart and the feet must be always transported separately.

4.2 *Transport procedure*

There are two ways to move the machine: By one person with the use of the transport wheels, or by two persons.

While transporting the machine in a van or truck, always block properly the feet, the water tray and the conveyor cart.

No part of the machine is designed for transport by crane.

4.3 *Storing of the machine*

If the machine is not going to be used for a long period, please take the following measures:

- Completely clean the machine.
- Empty the water cooling system.
- Take the water pump out of the slurry and clean it thoroughly.

The storage site must be clean, dry and at a constant temperature.

5 OPERATING THE MACHINE

Please find in this chapter advices to use the machine safely and correctly.

5.1 Installation

5.1.1 Information concerning the working site

- Remove from the site anything, which might hinder the working procedure.
- Make sure the site is sufficiently well lit.
- Observe manufacturer's conditions for connecting to power supplies.
- Place electric cables in such a way that damage is excluded.
- Make sure you have a continual adequate view of the working area so you can intervene in the working process at any time.
- Keep other staff out of the area, so you can work safely.
- Set the machine on the flat and stable ground.

5.1.2 Space required for operation and maintenance

In order to use and maintain the machine safely and correctly, leave 2 m in front and 1, 5 m around of the machine.

5.2 Cutting methods

To use the machine correctly, you must face it with one hand on the handle of the cutting head, and the other on the conveyor cart. Always keep your hands away from the moving blade.

To start the machine, open the switch cover and press the green button.

To stop either use the red button or press directly on the switch front cover.

5.2.1 Full depth or fixed cutting

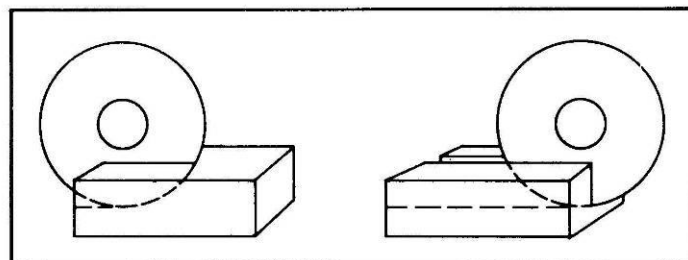

In full depth or fixed cutting, the cutting head is locked in a fixed position and the material is pushed into it as shown.

- Lower the cutting head to the desired cutting depth (in “through cutting”, lower cutting head until blade periphery reaches max. 3mm under the surface of the conveyor cart) by means of the handle on the blade guard.
- Fix the position by tightening the locking handle located on the side of the cutting head and set the depth stop screw correctly.

- Place the material on the conveyor cart and hold it firmly against the stop (and where appropriate against the guide-a-cut).
- Start the machine
- Push the conveyor cart slowly and without undue pressure towards the rotating blade and cut the material as shown on the picture.

Note: While recommended, it is not absolutely necessary to lock the cutting head into a given depth position when jam cutting. The desired cutting depth can be maintained by holding firmly the depth feed handle on the blade guard. If the full depth of cut requires excessive pressure (on very dense material e.g.) make 2 or 3 shallow cuts.

5.2.2 Multiple step cutting

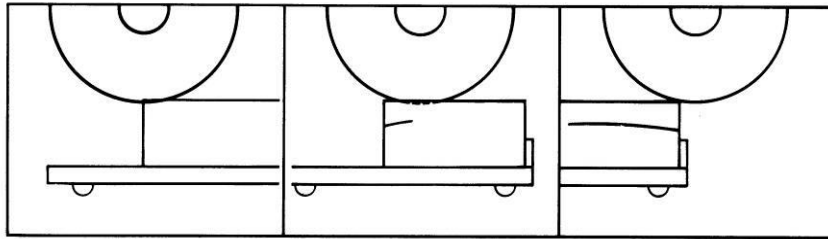

Multiple step cutting consists of moving the conveyor cart with the material to be cut back and forward under the rotating blade as shown.

- Place the material on the conveyor cart and hold it firmly against the stop (and where appropriate against the guide-a-cut) keeping the hands well away from the blade.
- Start the machine.
- Move conveyor cart forward near the blade and pull down the cutting head until blade is lowered to a point where it will lightly contact the surface of the material.
- Keep a constant pressure on the cutting head handle.
- Pass the material beneath with rapid full length strokes, taking a shallow cut (approximately 3 mm deep as shown on the picture) on the forward. On the backward stroke, lift the blade just clear over the cutting line.

5.2.3 45° bevel cuts

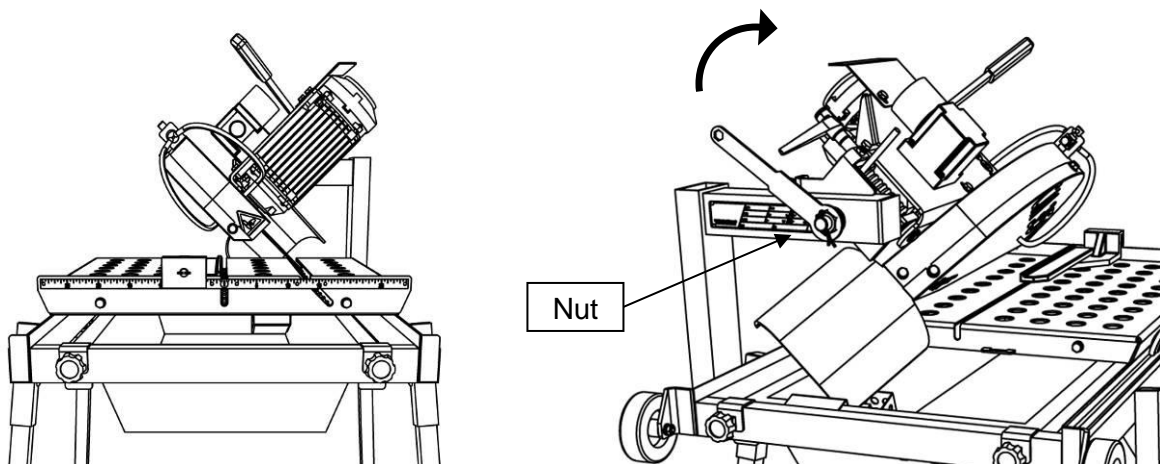

With the **CM 351** it is possible to make fixed or multiple step bevel cuts.

To tilt the cutting head to 45°, please follow the following instructions:

- Clear the conveyor cart in the front of the machine to give space to the pivot.
- Loosen **slightly** (1/8 turn is sufficient) the nut that supports the head.
- Rotate the head until it stops 45°.
- Tighten **strongly** back the nut that supports the head.
- Check by lowering the head down as the blade reaches correctly 3mm under the surface of the conveyor cart in the middle of the groove for cutting 45°.

Note: to reposition the head in the normal position, the procedure is the same by rotating the head in the opposite direction to the other stop. Make sure the nut that supports the head is **strongly** tighten. The stops are set at the factory; no adjustment shall be made normally.

5.2.4 Important advices for the cutting

- The **CM 351** is designed to cut material weight under 20kg and having dimensions smaller than 600x600x110mm.
- Before commencing work, check the fixing and stability of the tool.
- Select the right tools as recommended by the manufacturer depending on the material to be worked, the working procedure (dry or wet cut) to be carried out and the required efficiency.
- Apply cooling water continuously whilst cutting and in good time! Make sure the water tray contains enough water.
- When dry cutting, ensure sufficient dust extraction and wear a dust protection mask.
- When cutting work is finished, close the water-tap so you can remove the cut pieces from the conveyor cart without getting wet.
- In case the thermal protection trips, wait until the motor has cooled down before starting the machine again.

6 MAINTENANCE AND SERVICE

To ensure a long-term quality from the cutting and a safe functioning of the machine without any problem, please follow the maintenance plan below:

		Begin of the work	During changing the tool	End of the work	Every week	After a breakdown	After a damage
Whole machine	Visual control general aspect, water tightness						
	Clean						
Flange and blade fixing devices	Clean						
Motor cooling fans	Clean						
Water pump	Clean						
Conveyor cart	Clean						
Water tray	Clean						
Water hoses and nozzles	Clean						
Water pump filter	Clean						
Conveyor cart guiding bars	Clean						
Motor housing	Clean						
Reachable nuts and screws	Tighten up						

Maintenance of the machine

Always perform the maintenance of the machine with the machine isolated from the electrical supply.

Lubrication

The **CLIPPER** machine use life-lubricated bearings. Therefore, you don't need to lubricate the machine at all.

Cleaning of the machine

Your machine will last longer if you clean it thoroughly after each day of work, especially water pump, water pan (which can be removed for easy cleaning), motor and blade flange.

7 BREAKDOWN – CAUSES AND CURES

7.1 Breakdown-finding procedures

Should any breakdown occur during the use of the machine, turn it off, and isolate it from the electrical supply. Any works dealing with the electrical system or supply of the machine can only be carried out by a qualified electrician.

7.2 Trouble-shooting guide

Trouble	Possible source	Resolution
Motor is not running	No electricity	Check the electrical supply (fuse for example)
	Connection cable section too small	Change connection cable
	Defective switch	CAUTION : can only be solved by qualified electrician
	Defective motor	Change motor or contact motor manufacturer
	Defective connection cable	Change connection cable
Motor stops during the cutting, but can be restarted after a short period (overload protection)	Cutting advance too quick	Cut slowly
	Blade is blunt or glazed	Sharpen the blade in calcareous stone
	Defective blade	Change blade
	Wrong blade specification for the application	Change blade
No water on the blade	Not enough water in the pan	Refill the water tray
	Water pump is switched off	Switch the water pump on
	Water tap is closed	Open the water tap
	Water supply system is blocked	Clean water supply system
	Water pump is not working	Prime the pump Reactivate switch CAUTION : if switch trips again, problem can only be solved by a qualified electrician

7.3 Circuit diagram 230V

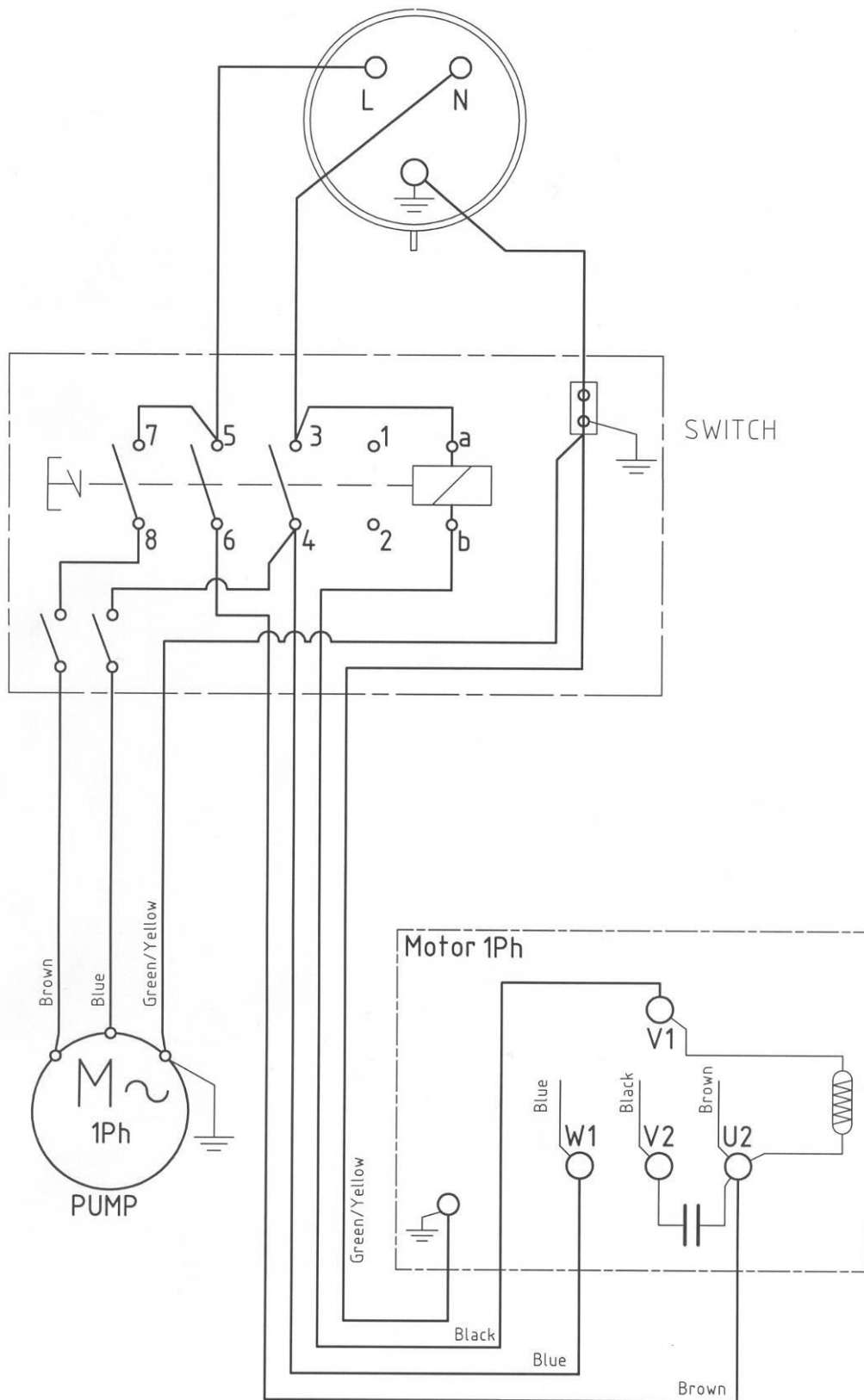

7.3 Circuit diagram for Able Motor 230v

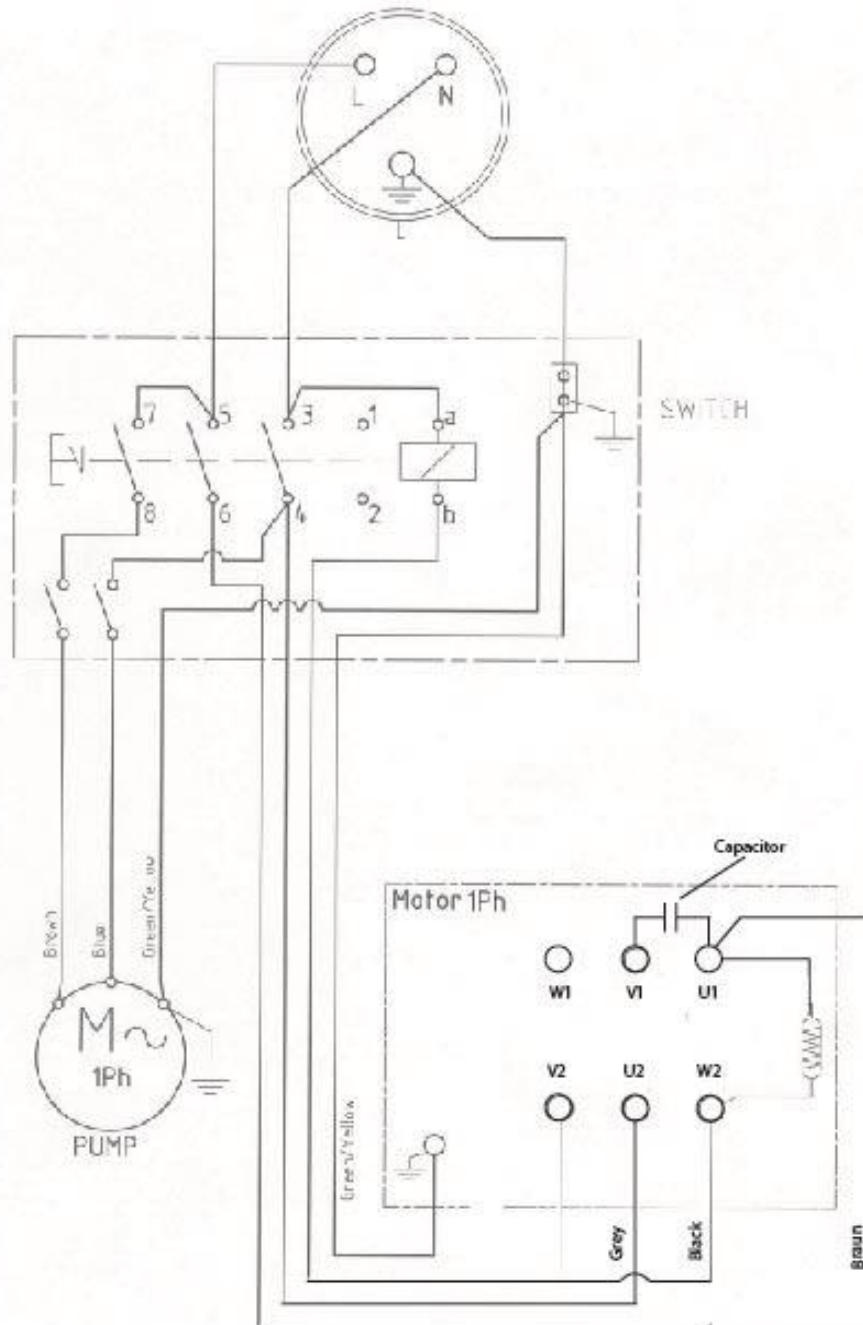

Customer service

When ordering spare parts, please mention:

- The serial number (7 digits)
- The code of the part
- The exact denomination
- The number of parts required
- The delivery address

Please indicate clearly the means of transportation required such as "express" or "by air". Without specific instructions, we will forward the parts through the means which seem appropriate to us --- but which is not always the quickest way.

Clear instructions will avoid problems and faulty deliveries.

If not sure, please send us the defective part.

In the case of a warranty claim, the part must always be returned for evaluation.

Spare parts for the motor can be ordered with the manufacturer of the motor or with their dealer, which is often quicker and cheaper!

This machine has been manufactured by:

Saint-Gobain Abrasives S.A.:
190, Bd. J. F. Kennedy
L-4930 BASCHARAGE
Grand-duché de Luxembourg
Tel. : 00352 50 401 1
Fax. : 00352 50 16 63
http://www.construction.norton.eu
Email : sales.nlx@saint-gobain.com

Guarantee can be claimed and technical support obtained from your local distributor where machines, spare parts and consumables can be ordered as well:

SAINT-GOBAIN ABRASIVES
INDUSTRIEWEG 21
9420 ERPE-MERE
BELGIUM
TEL: +32(0) 2 267 21 00

SAINT-GOBAIN ABRASIVES, S.R.O.
POČERNICKÁ 272/96, MALEŠICE
108 00 PRAHA 10
CZECH REPUBLIC
TEL: +420 255 719 326
FAX: +420 255 719 321

SAINT-GOBAIN ABRASIVES A/S
DYBENDALSVEJENGT 2,
DK-2630 TAASTRUP
DENMARK
TEL: +45 4675 5244

PO BOX 643706
FORTUNE TOWER OFFICE 2106
JLT BLOCK C
(NEXT TO METRO STATION)
JUMEIRA LAKE TOWER, DUBAI
UNITED ARAB EMIRATES
TEL: +971 4 431 5154
FAX: +971 4 431 5434

SAINT-GOBAIN ABRASIFS
RUE DE L'AMBASSADEUR - B.P.8
78 702 CONFLANS CEDEX
FRANCE
TEL: +33 (0)1 34 90 40 00
FAX: +33 (0)1 39 19 89 56

SAINT-GOBAIN ABRASIVES GMBH
BIRKENSTRASSE 45-49
D-50389 WESSELING
GERMANY
TEL: +49(0)2236703-1
+49(0)22368996-0
+49 (0)2236 8911-0
FAX: +49(0)2236703-367
+49(0)22368996-10
+49 (0) 2236 8911-30

FÜR DEN FACHHANDEL
ÖSTERREICH
TEL: +43 (00) 662 430 076

SAINT-GOBAIN ABRASIVES KFT.
1225 BUDAPEST
BÁNYALÉG U. 60/B.
HUNGARY
TEL: +36 1 371 22 50
FAX: +36 1 371 22 55

SAINT-GOBAIN ABRASIVI S.P.A
VIA PER CESANO BOSCONI 4
I-20094 CORSICO MILANO
ITALY
TEL: +39 02 44 851
FAX: +39 02 44 78 266

SAINT-GOBAIN ABRASIVES S.A.
190 RUE J.F. KENNEDY
L-4930 BASCHARAGE
GRAND DUCHE DE LUXEMBOURG
TEL: +352 50 401 1
FAX: +331 83 717 792
NO. VERT (FRANCE): 0800 906 903

SAINT-GOBAIN ABRASIFS, S.A.
2 ALLÉE DES FIGUIERS
AIN SEBAÂ - CASABLANCA
MOROCCO
TEL: +212 5 22 66 57 31
FAX: +212 5 22 35 09 65

SAINT-GOBAIN ABRASIVES BV
GROENLOSEWEG 28
7151 HW EIBERGEN
P.O. BOX 10
7150 AA EIBERGEN
THE NETHERLANDS
TEL: +31 545 466466
FAX: +31 545 474605

SAINT-GOBAIN ABRASIVES AS
KARIHAUGVEIEN, 89
0186 OSLO
NORWAY
TEL: +47 63 87 06 00
FAX: +47 63 87 06 01

SAINT-GOBAIN HPM POLSKA SP. Z O.O.
UL. NORTON 1, 62-600 KOŁO
62-600 KOŁO
POLAND
TEL: +48 63 26 17 100
FAX: +48 63 27 20 401

SAINT-GOBAIN ABRASIVOS, L. DA
ZONA INDUSTRIAL DA MAIA
I-SECTOR VIII, NO. 122
APARTADO 6050
4476 - 908 MAIA
PORTUGAL
TEL: +351 229 437 940
FAX: +351 229 437 949

SAINT-GOBAIN GLASS
BUSINESS UNIT ABRASIVI
PUNCT DE LUCRU : LOC.VETIS, JUD.
SATU MARE 447355
STR. CAREIULUI 11
PARC INDUSTRIAL RENOVATIO
ROMANIA
TEL: +40 261 839 709
FAX: +40 261 839 710

SG HPM RUS
58, F. ENGELS STR.
STROENIE 2
105082 MOSCOW
RUSSIA
TEL: +74 955 408 355
FAX: +74 959 373 224

SAINT-GOBAIN
ABRASIVES (PTY) LTD
2 MONTEER ROAD
ISANDO 1600
P.O. BOX 67
SOUTH AFRICA
TEL: +27 11 961 2000
FAX: +27 11 961 2184/5

SAINT-GOBAIN ABRASIVOS, S.A.
CTRA. DE GUIPÚZCOA, KM. 7,5
E-31195 BERRIOPLANO (NAVARRA)
SPAIN
TEL: +34 948 306 000
FAX: +34 948 306 042

SAINT GOBAIN ABRASIVES AB
GÅRDSFOGDEVÄGEN 18A
168 66 BROMMA • SVERIGE
SWEDEN
TEL: +46 8 580 881 00
FAX: +46 8 580 881 30

SAINT-GOBAIN INOVATIF MALZEMELER VE
ASINDIRICI SAN. TIC. AS.
ALTAYÇEŞME MAH. ÇAMLI SOK. NO:21 ESAS
OFISPARK KAT:9 34843
MALTEPE, İSTANBUL • TURKEY
TEL: 0090-216-217 12 50
FAX: 0090-216-442 40 74

SAINT-GOBAIN ABRASIVES LTD.
UNICORN HOUSE UNIT 1, AMISON CLOSE
REDHILL BUSINESS PARK
STAFFORD ST161WB
UNITED KINGDOM
TEL: +44 1785 279 553
FAX: +44 1785 213 487



Saint-Gobain Abrasifs
190 Rue J.F. Kennedy
L-4930 Bascharage
Grand Duché de Luxembourg
Tel: +352 50 4011
Fax: +331 83 717 792
no. vert (France) 0800 906 903

www.nortonabrasives.com/fr-fr