

CK31

SPARE PARTS LIST



1 Spare parts list

POS.	Art.Nr.	DESCRIPTION	TYPE(*)
1001	NA	ENGINE SUPPORT FRAME	H
1002	310034109	SCREW M16X80 LEFT THR. DIN 931 GALV.	S
1003	NA	WASHER A17 DIN 125 GALV.	H
1004	310035477	MOBILE COLLAR	R
1005	310034122	SHAFT-SCREW M10X35 A2	W
1006	310035475	INNER COLLAR	S
1007	310034748	BLADE SUPPORT AXLE	S
1008	310004004	BEARING UCP 208 ø40	W
1009	NA	SCREW M12x50 DIN 933	H
1010	NA	WASHER 13 DIN7349 GALV.	H
1011	NA	WASHER A13 DIN 125 GALV.	H
1012	NA	NUT M12 GALV.	H
1013	310061234	BLADE SUPPORT EXTRACTOR	S
1014	310036571	BLADE SHAFT	S
1015	310412610	KEY 12X8X40 DIN 6885	S
1016	310412611	KEY 12X8X100 DIN 6885	S
1017	310302245	PULLEY BLADE SHAFT	S
1018	NA	SCREW M6X10 DIN 916 GALV.	H
1019	310412626	CIRCLIPS A40X1,75 DIN 471	S
1020	310034110	SCREW M16X80 RIGHT THR. DIN 931 GALV.	S
1023	NA	PIN 5X50 DIN 94	H
1024	NA	WASHER A 25 DIN 125 GALV.	H
1025	510097273	HYDRAULIC CYLINDER AXLE	S
1030	NA	SCREW M8X20 DIN 7991 GALV.	H
1031	NA	WASHER 8,4 DIN 6340 GALV.	H
1032	310035319	WHEEL PE200-50-5K-S	W
1033	NA	PIVOTING FRAME	H
1034	NA	SCREW M12X40 DIN 933 GALV.	H
1035	NA	WASHER 13 DIN 125 GALV.	H
1036	310035320	BEARING FY35TF	W
1037	510117570	SPLASH GUARD FIXING	S
1038	NA	NUT M12 GALV.	H
1039	NA	SPLASH GUARD	H
1040	NA	WASHER	H
1041	NA	NUT	H
1042	NA	SCREW	H
1043	NA	HOSE CLAMP	H
1046	310313428	NOTCHED SCREW M8X16 GALV.	S
1047		WASHER 8,4X40X1,5 GALV.	H
1048	310035321	WHEEL HUB	W
1049	NA	SCREW M8X16 GALV.	H
1050	310035321	WHEEL BAND Ø300x75x220	W
1051	310035480	FEED MOVEMENT GEAR BOX	S

1052	NA	SCREW M12X30 DIN 7984 GALV.	H
1053	NA	WASHER 13 DIN 125 GALV.	H
1054	NA	SPRING WASHER 25X12,2X1,5 DIN 2093-STEEL	H
1055	510117571	SETTING SUPPORT	S
1056	NA	NUT M12 GALV.	H
1057	NA	SCREW M8X90 DIN 912 GALV.	H
1058	NA	WASHER 8,4 DIN 7349 GALV.	H
1059	NA	NUT M8 GALV.	H
1060	NA	SCREW M12X20 DIN 912 GALV.	H
1061	NA	SCREW M16X130 DIN 933 GALV.	H
1062	NA	WASHER 17 DIN 125 GALV.	H
1063	NA	SPRING WASHER 16X8,2X0,6 DIN 2093-STEEL	H
1064	NA	NUT M16 DIN 934	H
1065	NA	NUT BM16 DIN 439	H
1066	NA	NUT M8 DIN557 GALV.	H
1067	510117572	SETTING SUPPORT	S
1068	310396984	GUARD FOR COLLARS	S
1069	510117573	SHAFT GUARD-DOWN PART	S
1070	310355364	BELT GUARD-DOWN PART	S
2001	NA	ENGINE DEUTZ F2L2011	H
2002	NA	SCREW M10X100 DIN 933 GALV.	H
2003	NA	WASHER A10,5 DIN 125 GALV.	H
2004	NA	ENGINE SPACER	H
2005	NA	WASHER 13 DIN 6340 GALV.	H
2006	NA	NUT M12 DIN 934 GALV.	H
2007	NA	SCREW M12X120 DIN 931 GALV.	H
2008	NA	SCREW M12X120 DIN 912 GALV.	H
2010	310394989	WASTE PIPE	W
2011	510117595	PROTECTING PLATE	S
2012	NA	NOTCHED WASHER S12	H
2013	510117894	GAS CABLE SUPPORT	S
2016	310372644	SHORT SPACER	S
2017	510094473	LONG SPACER	S
2018	NA	SCREW M10X40 DIN 933 GALV.	H
2019	NA	NOTCHED WASHER S10 GALV.	H
2020	510117895	PULLEY DEUTZ	S
2023	NA	SCREW M8X60 DIN 933 GALV.	H
2024	NA	NUT M8 DIN 934 GALV.	H
2025	NA	NOTCHED WASHER S8 GALV.	H
2026	510117965	SUPPORT FOR BELT TENSIONING PULLEY	S
2027	NA	SCREW M10X20 DIN 912 GALV.	H
2028	NA	NOTCHED WASHER S10 GALV.	H
2029	NA	WASHER 10 DIN 7349 GALV.	H
2030	NA	SCREW M20X55 DIN 912 GALV.	H
2031	510116633	CIRCLIPS 42X1,75 DIN 472 GALV.	S

2032	310004241	BALL BEARING 6004 2RS	W
2033	510104961	BELT TENSIONING PULLEY	S
2034	NA	WASHER 20X28X1	H
2035	NA	NUT M20 DIN 980	H
2036	310033095	BELT XPZ 1700	W
2040	510104555	PULLEY FOR REVERSING GEAR	S
2041	510117583	KEY 8X7X32 DIN 6885 A	S
2042	NA	SCREW M6X10 DIN 913	H
2043	310035324	REVERSING GEAR	S
2044	NA	SCREW M8X110 DIN 912 GALV.	H
2045	NA	NOTCHED WASHER S8 GALV.	H
2046	NA	WASHER 8,4 DIN 7394 GALV.	H
2047	510117949	SUPPORT FOR BRAKE CABLE	S
2048	NA	WASHER 8,4 DIN 125	H
2049	510117583	KEY 8X7X32 DIN 6885 A	S
2050	NA	SCREW M6X6 DIN 916	H
2051	510108371	PULLEY FOR REVERSING GEAR	S
2052	310033094	BELT XPA 782	W
2056	510117898	EYE-SCREW M8X60 DIN 444	S
2057	NA	NUT M8 DIN 934	H
2058	NA	NOTCHED WASHER S8	H
2059	NA	NOTCHED SCREW M10X20	H
2060	NA	BOLT	H
2061	510102196	SUPPORT FOR BELT TENSIONING PULLEY	S
2062	NA	SPRING WASHER 20X10,2X1,1 DIN 2093 GALV.	H
2063	NA	NUT M10 DIN 936	H
2064	NA	NOTCHED SCREW M10X20	H
2065	510111632	BOLT	S
2066	510111633	CIRCLIPS 42X1,75 DIN 472	S
2067	310004241	BALL BEARING 6004 2RS	W
2068	510102195	BELT TENSIONING PULLEY	S
2069	510117634	CIRCLIPS 20X1,2 DIN 471	S
2070	510117781	SPRING RZ-156-HI	W
2071	NA	SCREW M8X25 DIN 933	H
2075	310409869	ENGINE OUTPUT SHAFT	S
2076	NA	NOTCHED WASHER S14 GALV.	H
2077	NA	SCREW M14X35 DIN 933 GALV.	H
2078	NA	NOTCHED WASHER S16 GALV.	H
2079	NA	SCREW M16X40 DIN 933 GALV.	H
2080	310412622	KEY 14X9X100 DIN 6885	S
2081	310412625	BALL BEARING 6310 2RSC3	W
2082	510117782	MOTOR FLANGE	S
2083	NA	NOTCHED WASHER S10 GALV.	H
2084	NA	SCREW M10X25 DIN 912 GALV.	H
2085	310409939	ENGINE PULLEY	S

2086	310033091	BELTS XPZ 1337 LW (SET OF 8)	W
2090	310058069	SUPPORT FOR BELT TENSIONING PULLEY	S
2091	310058061	NUT FOR BELT TENSIONING PULLEY	S
2092	NA	WASHER 10 DIN 7349 GALV.	H
2093	310058071	TENSIONING SCREW	S
2094	310058049	SHAFT FOR BELT TENSIONING PULLEY	S
2095	310374635	CIRCLIPS 47X1,75 DIN 472	S
2096	310004155	BALL BEARING 6005-2RS	W
2097	510093152	TENSIONING PULLEY	S
2098	310006659	CIRCLIPS 20X1,2 DIN 471	S
2099	NA	SCREW M14X80 DIN 933 GALV.	H
2100	NA	NOTCHED WASHER S14 GALV.	H
2101	NA	SCREW M10X70 DIN 933 GALV.	H
2102	NA	NOTCHED WASHER S10	H
2103	NA	WASHER 10 DIN 7349 GALV.	H
2104	NA	SPRING WASHER 20X10,2X1,1	H
2107	310308881	EXHAUST PIPE	W
2108	510117747	EXHAUST CAP	S
2109	510117748	PIPE HOLDER	S
2110	510117749	SUPPORT	W
2111	510117750	EXHAUST LAGGING	W
2116	510103627	ELBOW FOR AIR FILTER	W
2117	510117752	TIGHTENING RING	W
2118	510117783	AIR FILTER TUBE (SHORT)	W
2119	510117753	MAINTENANCE WARNING DEVICE	W
2120	310329674	AIR FILTER CAP	S
2121	310035327	AIR FILTER COMPLETE	W
	310388732	AIR FILTER CARTRIDGE	W
2122	310414154	AIR FILTER TIGHTENING RING	W
2123	510117764	AIR FILTER SUPPORT PLATE	S
2128	NA	FUEL HOSE 350MM	H
2129	NA	ELBOW FOR FUEL TUBE	H
2130	NA	COPPER RING DIN7603 A	H
2131	NA	FUEL HOSE 400MM	H
2132	310035461	FUEL TANK	S
2133	NA	O-RING DIN 3771 24X2 NBR 872	H
2134	NA	O-RING DIN 3771 12X2,5 NBR 872	H
2135	NA	LABEL DIESEL	H
2136	NA	FUEL HOSE	H
2137	NA	ELBOW FOR FUEL TUBE	H
2138	NA	COPPER RING DIN7603 A	H
2139	NA	FUEL HOSE	H
2140	NA	TIGHTENING RING	H
2141	NA	FUEL HOSE B NW6	H
2142	510117765	TANK SUPPORT	S

2143	510117766	TANK SUPPORTING BAR	S
3001	NA	SCREW M5X16 DIN 933 GALV.	H
3002	NA	WASHER 5,3 DIN 125 GALV.	H
3003	310313429	NIPPLE MAGURA 24-ZK	S
3004	310326267	BRAID FOR CABLE DEPTH INDICATOR	W
3005	310317503	SHEATH CABLE DEPTH INDICATOR	W
3006	510117914	HOSE HOLDER	S
3007	310313441	HOSE	W
3008	NA	SCREW M5X30 DIN 912 GALV.	H
3010	310317504	CABLE HOLDER	S
3011	NA	NUT M5 DIN 934 GALV.	H
3012	NA	WASHER 5,3 DIN 125 GALV.	H
3015	310366793	SETTING SCREW	S
3016	NA	SCREW M5X5 DIN 916	H
3017	NA	NUT M8 DIN 934 GALV.	H
3018	310366794	CABLE FIXATION	S
3019	510117915	PROTECTION TUBE	W
3020	310337454	SPRING RZ-121-CX-VA	W
3021	NA	SCREW M6X8 DIN 7985	H
3022	NA	WASHER 6,4 DIN 125 GALV.	H
3023	510117916	POINTER FOR DEPTH GAUGE	S
3024	510117917	DEPTH GAUGE SUPPORT	S
3025	NA	NUT M12 GALV.	H
3026	NA	WASHER A13 DIN 125 GALV.	H
3027	NA	WASHER 12X18X1 DIN 988	H
3028	510117918	LABEL SCALE (METRIC)	S
3029	NA	BALL BEARING 12X28X8 6001 2RS	H
3030	510117950	DEPTH GAUGE WHEEL	S
3031	NA	SCREW M12X50 DIN 933 GALV.	H
3032	NA	LABEL SCALE (IMPERIAL)	H
3035	310356722	GASKET FOR SWITCH	W
3036	310047375	SUPPORT FOR SWITCH	S
3038	310044419	SWITCH	W
3039	310035491	FEED MOVEMENT LEVER	S
3040	310312389	CAP	S
3041	NA	SCREW M12X50 DIN 933 GALV.	H
3042	NA	SPRING WASHER 25X12,2X1,5 DIN 2093	H
3043	510117966	SUPPORT PLATE CABLE HYDROSTATIC GEAR BOX	S
3044	NA	WASHER WC 14 DU	H
3045	NA	WASHER A13 DIN 125 GALV.	H
3046	NA	NOTCHED WASHER S14 GALV.	H
3047	NA	NUT M12 DIN 934 GALV.	H
3050	NA	SCREW M6X8 DIN 7985	H
3051	NA	WASHER 6,4 DIN9021	H
3052	NA	SCREW M8X25 DIN 933 GALV.	H

3053	510094863	EYE FOR CABLE HYDROSTATIC GEAR BOX	S
3054	NA	NUT M8 GALV.	H
3055	NA	NUT M16X1 DIN 936 GALV.	H
3056	310035479	CABLE HYDROSTATIC GEAR BOX	W
3057	510117967	SUPPORT PLATE FOR CABLE HYDR. GEAR BOX	S
3058	NA	NUT M16X1 DIN 936 GALV.	H
3059	510094863	EYE FOR CABLE HYDROSTATIC GEAR BOX	S
3060	NA	BOLT	H
3061	NA	WASHER 16X0,5 DIN 988	H
3062	NA	BALL BEARING 61802 RS	H
3063	510117919	SETTING PLATE	S
3064	NA	WASHER A10,5 DIN 125 GALV.	H
3065	NA	NUT M10 DIN 934 GALV.	H
3068	NA	NUT M8 GALV.	H
3069	NA	WASHER A8,4 DIN 125 GALV.	H
3070	510117921	SUPPORT	S
3071	NA	WASHER 8,4 DIN 7349 GALV.	H
3072	NA	SCREW M8X60 DIN 933 GALV.	H
3075	NA	NUT M8 DIN 934 GALV.	H
3076	510117922	STOP	S
3080	NA	NUT M6 GALV.	H
3081	NA	WASHER 6,4 DIN 9021	H
3082	510117924	SPRING RZ-141-FI	W
3083	NA	NUT M6 DIN 934 GALV.	H
3084	510117925	ARM FOR NULL-SETTING	S
3085	NA	SCREW M6x25 DIN933 GALV.	H
3086	510117926	FIXING SQUARE	S
3087	510117759	SPACER WASHER	S
3088	NA	WASHER A8,4 DIN 125 GALV.	H
3089	NA	NUT M8 GALV.	H
3093	NA	WASHER 8,4 DIN 7394 GALV.	H
3094	NA	SCREW M8X140 DIN 933 GALV.	H
3095	NA	NOTCHED WASHER S8 GALV.	H
3096	NA	NUT M8 GALV.	H
3099	510117760	TIGHTENING RING	S
3100	510117761	PROTECTION TUBE FOR CABLES	W
3102	510113378	BRASS NUT 1-8	S
3103	310035462	OIL TANK	S
3104	510117762	SCREW-NIPPLE	W
3105	510113379	GASKET VITON_21-30-2	W
3106	510117897	OIL TANK SUPPORT	S
3107	310366794	CABLE FIXATION	S
3108	310313429	NIPPLE MAGURA-24 ZK	W
3109	NA	NUT M5 DIN 934 GALV.	H
3110	510117762	SCREW-NIPPLE 6,5 23	S

3113	NA	WASHER 6,4 DIN 9021 GALV.	H
3114	310047393	CABLE PARKING BRAKE	W
3115	310047397	CABLE PARKING BRAKE	W
3116	310047398	CABLE PARKING BRAKE	W
3117	510113744	GETRIEBEENTLUEFTUNG	S
3119	NA	NUT M8 GALV.	H
3120	NA	NOTCHED WASHER S8 GALV.	H
3121	NA	SCREW M8X20 DIN7991 GALV.	H
3122	310404221	GAS HANDLE COMPLETE	S
3123	310047374	SCREW-NIPPLE	S
3124	310047374	BRAID FOR GAS CABLE	W
3125	310047374	SHEATH CABLE A GAZ	W
3126	310047374	SCREW-NIPPLE	S
3127	310047374	GAS CABLE SUPPORT	S
3128	310047374	NUT M6 DIN 439 GALV.	S
3129	310047374	SCREW M6X6 DIN 916	S
3130	310047374	NUT M8 DIN 934 GALV.	S
3131	310047374	WASHER 8,4 DIN 9021 GALV.	S
4001	310313444	SETTING OF RAISE-LOWER SPEED	W
4002	NA	NOTCHED WASHER S20 GALV.	H
4003	510117847	HYDRAULIC ELBOW	W
4004	310388723	OIL HOSE DN6-1 1300MM	W
4005	310388722	OIL HOSE DN6-1 425MM	W
4006	510117848	HYDRAULIC ELBOW	W
4007	310366685	HYDRAULIC CONNECTOR	W
4008	310035463	ELECTRO-HYDRAULIC PUMP	S
4009	510117844	CLOSING SCREW G1/8"	W
4010	510117927	SPACER	S
4011	NA	WASHER A8,4 DIN 125 GALV.	H
4012	NA	NOTCHED WASHER S8 GALV.	H
4013	NA	SCREW M8X55 DIN933 GALV.	H
4016	510094181	NUT WITH KNOB M12 IG DIN 6336	S
4017	NA	NUT M12 DIN 936 GALV.	H
4018	NA	SPRING WASHER 25X12,2X1,5 DIN 2093	H
4019	NA	WASHER WC 14 DU	H
4020	510117928	TUBE FOR CHAIN CPL.	S
4021	NA	WASHER A13 DIN 125 GALV.	H
4022	310313413	RAISE-LOWER SPINDLE	S
4023	310313414	DEPTH LIMITOR	S
4024	310313415	CHAIN LOCK 3/4"	W
4025	310313417	ROLLER CHAIN 3/4"x7/16" 12B-1 L=666,75	W
4026	510117845	HYDRAULIC CONNECTOR	W
4027	310035464	HYDRAULIC CYLINDER	S
4028	310313420	SPRING RZ-121CX VA	W
4029	NA	SCREW M10X20 DIN 912 GALV.	H

4030	NA	WASHER 8,4 DIN 7349 GALV.	H
4031	NA	NUT M8 GALV.	H
4032	NA	SCREW M8X30 DIN7991 GALV.	H
4037	NA	ELECTRIC CABLE	H
4038	NA	ELECTRIC CABLE	H
4039	NA	ELECTRIC CABLE	H
4040	NA	ELECTRIC CABLE	H
4041	310033253	BATTERY MOLL 12V 46AH	W
4045	NA	SCREW M6X16 DIN 912 GALV.	H
4046	NA	NOTCHED WASHER S6 GALV.	H
4047	510117898	EYE-SCREW M8X60 DIN 444	S
4048	NA	NUT M8 DIN 934	H
4049	NA	NOTCHED WASHER S8	H
5001	510117849	FRONT COVER CK31/C31	S
5002	510117903	RIGHT BELT GUARD	S
5003	310401700	RIGHT SUPPORT LIFTING HOOK	S
5004	510117905	RIGHT FRAME WALL	S
5005	310035493	LIFTING HOOK CK31/C31	S
5006	510093734	LEFT SUPPORT LIFTING HOOK	S
5007	510117906	LEFT FRAME WALL	S
5008	310401699	BELT GUARD	S
5009	510117850	BACK COVER CK31/C31	S
5010	310404222	MAIN BOARD	S
5011	510117964	FRONT HOUSING CK61/CK31/C61/C31	S
5013	510117953	REAR CAP CK61/CK31/C61/C31	S
5014	510117951	CONTROL PANNEL	S
5018	310312134	CAP FOR BELT TENSION CHECK KT29	S
5019	510117952	LOCKING PLATE	S
5020	310035500	HANDLE	S
5021	310035501	HANDLE PVC D=24MM 140MM	S
5025	NA	LABEL DIESEL	H
5026	510117968	LABEL DEPTH LIMIT	S
5027	510117969	LABEL OIL LEVEL CONTROL	S
5028	510117970	LABEL SPEED CONTROL	S
5029	510117971	LABEL RAISE-LOWER SPEED	S
5030	510117972	LABEL FEED MOVEMENT HANDLE	S
5031	510117973	LABEL BLADE ROTATION SPEED	S
5032	510117974	LABEL NOISE PROTECTION	S
5035	510117975	LABEL BELT TENSION	S
5036	510117936	LABEL DIRECTION	S
5037	510117935	LABEL LIFTING HOOK	S
5038	NA	MACHINE DESCRIPTION PLATE	H
5040	310034123	EYE-SCREW M12 DIN 580-C15 GALV.	S
5041	510117934	EYE-NUT M10 DIN 582-C15 GALV.	S
6001	510117851	COMMAND BOARD	S

6002	310313482	COMMAND BOARD SUPPORT	S
6003	310073636	BATTERY CHARGE WARNING LIGHT	W
6004	310073632	EMERGENCY STOP BUTTON	W
6005	510117852	FIXING SQUARE PART	S
6006	310073635	EMERGENCY STOP SWITCH	W
6007	510117853	TIGHTENING RING	S
6008	310073637	OIL LEVEL WARNING LIGHT	W
6011	310064440	HOURMETER	S
6012	310313483	ENGINE TEMPERATUR METER	S
6013	310313523	RPM-METER	S
6014	510117933	CAP TO STARTER	S
6015	310035478	STARTER	W
6016	310035465	LEVER	S
6017	NA	NUT M6 DIN 934 GALV.	H
6018	510117932	SUPPORT PLATE	S
6019	NA	SCREW M6X16 DIN 912 GALV.	H
6020	510117931	SUPPORT PLATE	S
6021	310313524	RELAI_0-332-204-125	W
6022	NA	SCREW M6X25 DIN 7985	H
6023	NA	NOTCHED WASHER S6 GALV.	H
7001	310024380	BLADE GUARD 700MM CPL.	S
7002	310313525	BLADE GUARD OPENING HALF 700MM	S
7003	310313526	REAR BLADE GUARD 700MM	S
7004	510117896	BUMPER ZYL 25X25XM6	W
7005	310313528	HINGE	S
7006	310313528	HINGE	S
7007	310313529	HINGE SUPPORT	S
7008	510100130	FLAP GUARD	W
7009	310047378	WATER INJECTOR	S
7010	310047378	NOZZLE	W
7011	310047378	GASKET	W
7012	310313545	HANDLE	S
7013	NA	LABEL ARROW	H
7016	310047378	TIGHTENING RING 27,0 G	S
7017	310047378	HOSE PVC 13x3,5x150MM	W
7018	310047378	Y-CONNECTOR YS-10	W
7019	310047378	HOSE PVC 13X3,5	W
7020	310047378	GEKA CONNECTOR MS 1/2"	W
7021	310047378	GEKA CONNECTOR MS 3/4" 111A	W
7022	310047378	WATERCOCK 2-IG 3/4"	W
7023	310047378	REDUCTION NIPPLE 3/4"-1/2"	W
7024	310047378	COCK SUPPORT	S
7025	310047378	GEKA CONNECTOR MS 1/2" 110	W
7030	310047376	SCREW M8X25 DIN 933 GALV.	S
7031	310047376	NUT M8 DIN 557	S

7032	310047376	SCREW M20X90 DIN 933 GALV.	S
7033	310047376	GUIDE-A-CUT SUPPORT	S
7034	310047376	NUT M20 DIN 934 GALV.	S
7035	310047376	SCREW M6X25 DIN 933 GALV.	S
7036	310047376	NUT BIW V-FORM M6 GALV.	S
7037	310047376	SPRING RZ-162 AI	W
7038	310047376	POINTER	S
7039	310047376	SCREW M6X12 DIN 933 GALV.	S
7040	310047376	NUT BIW V-FORM M6 GALV.	S
7043	310313428	NOTCHED SCREW M8X16	S
7044	310312135	SPRING TS 12	W
7045	310336770	BOLT	S
7046	310336771	LOCKING HANDLE	S
7047	NA	WASHER 8,4 DIN 9021 GALV.	H
7048	NA	NUT M8 GALV.	H
7051	510117930	FIXATION SQUARE	S
7052	310313541	GUIDE-A-CUT CPL.	S
7053	310313543	EYE-SCREW M10 DIN 580	S
7054	310035313	WHEEL	W
7055	310035492	GUIDING NEEDLE	W
7056	510117929	GUIDE-A-CUT	S
7057	310328620	TELESCOPIC GUIDE	S
7060	310331640	ROPE CATCH 3-7_MM	S
7061	NA	ROPE D=6MM	H
7062	510117896	BUMPER CYL._25x25xM6	W

(*): S = Spare part, W = Wear part, H = Hardware, NA = Not Available

NA = Not Available / this component is not available as wear part.

H : Not supplied alone / this component is a component standard which you can easily find at all the standard retailers of parts. All the standard components of assembly have a quality grade 8.8. We recommend to don't use a quality grade lower than 8.8.

W : Wear parts are worn out through normal use of the machine. The use period depends a lot on the intensity of work of the machine.

Wear parts must be serviced, used and eventually changed following the indications of the manufacturer. Any wear due to normal use of the machine will not be considered as a case of warranty.

S : Genuine CLIPPER replacement parts should always be used.

2 Exploded parts drawings

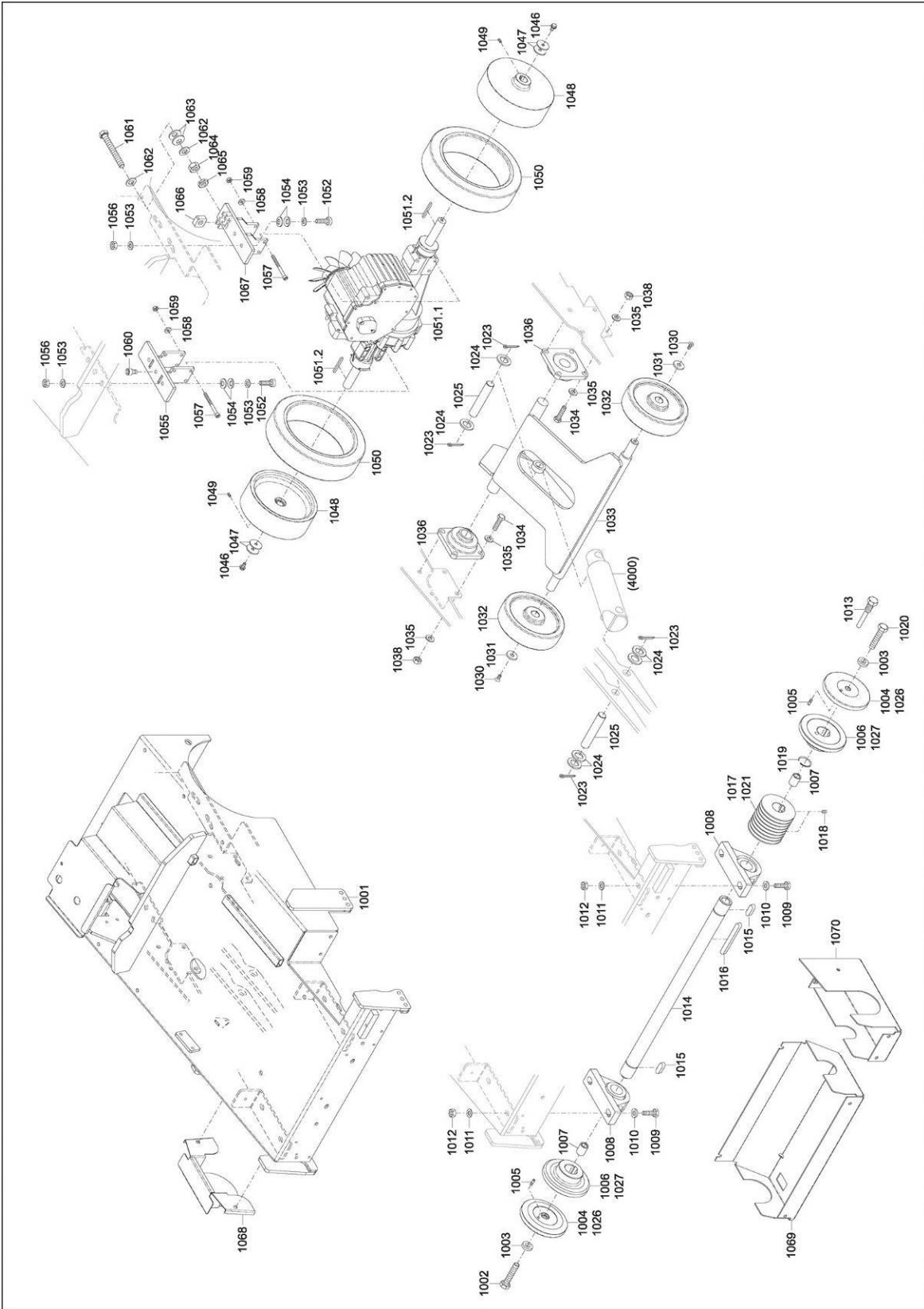

- 1022
- 1028
- 1029
- 1037
- 1038
- 1040
- 1041
- 1042
- 1043
- 1044
- 1045
- 1067

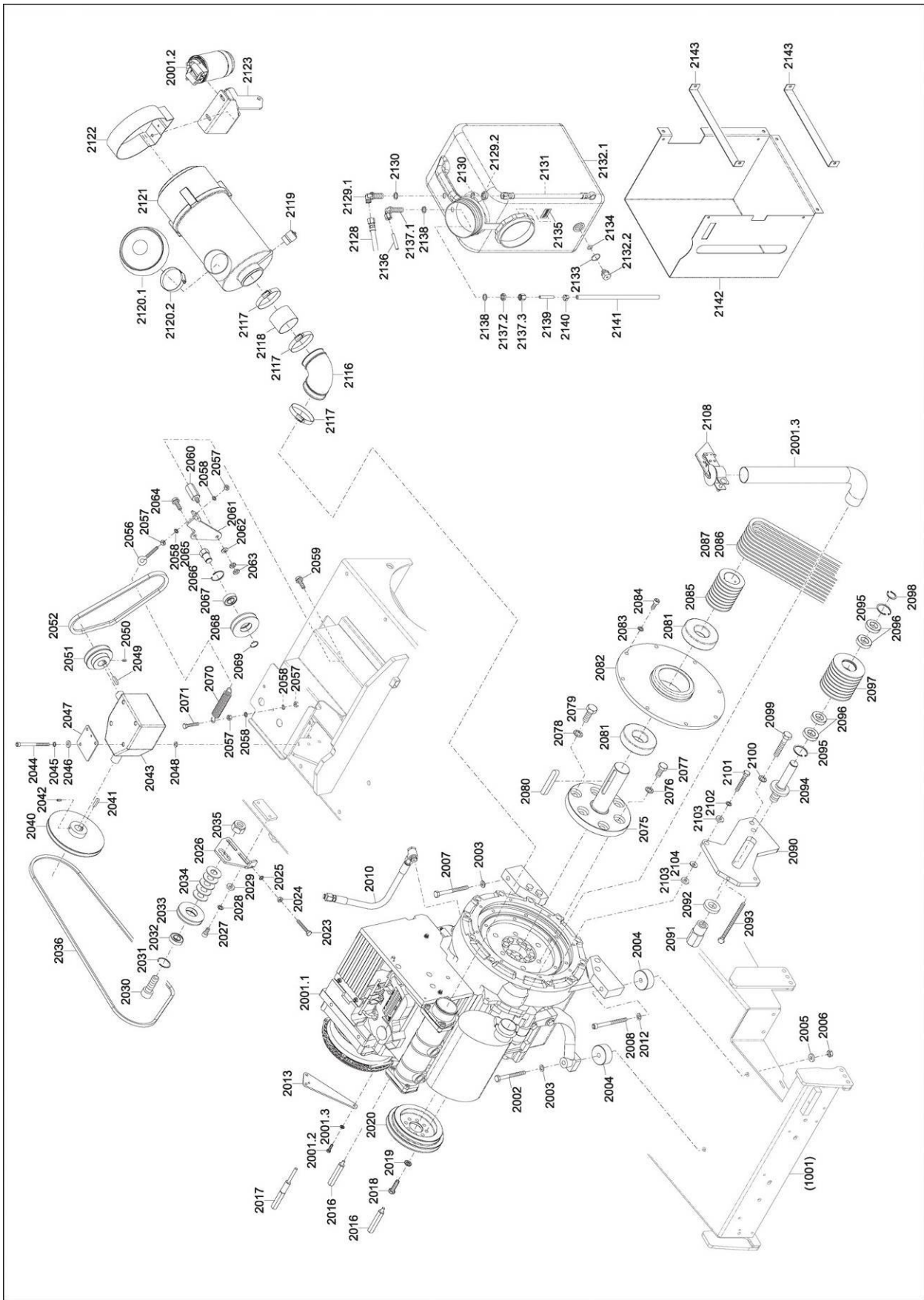

- 2011
- 2021
- 2022
- 2037
- 2038
- 2039
- 2053
- 2054
- 2055
- 2072
- 2073
- 2074
- 2088
- 2089
- 2105
- 2106
- 2109
- 2110
- 2111
- 2112
- 2113
- 2114
- 2115
- 2124
- 2125
- 2126
- 2127

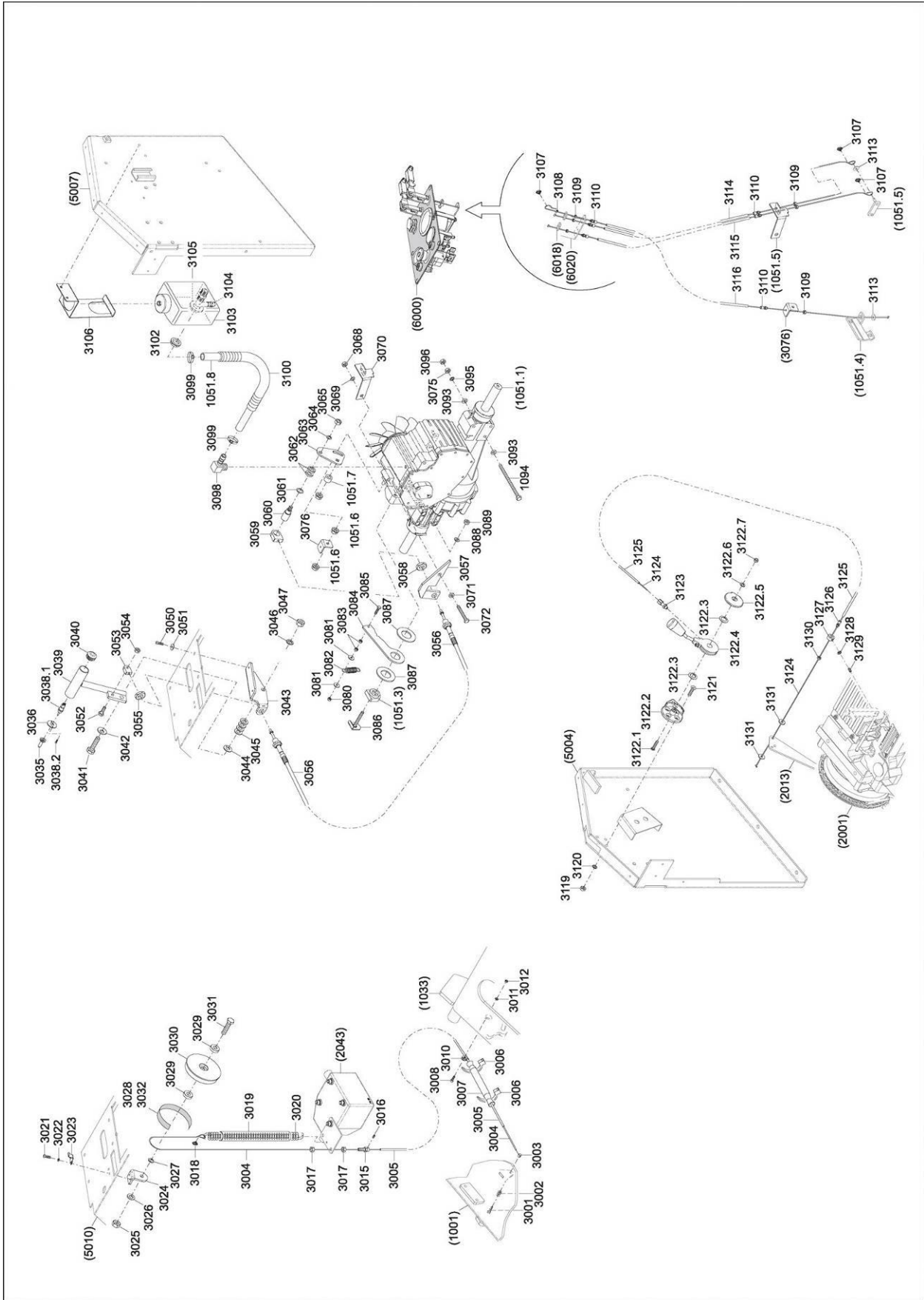

- 3013
- 3014
- 3033
- 3034
- 3048
- 3049
- 3066
- 3067
- 3073
- 3074
- 3077
- 3078
- 3079
- 3090
- 3091
- 3092
- 3097
- 3101
- 3111
- 3112
- 3117
- 3118

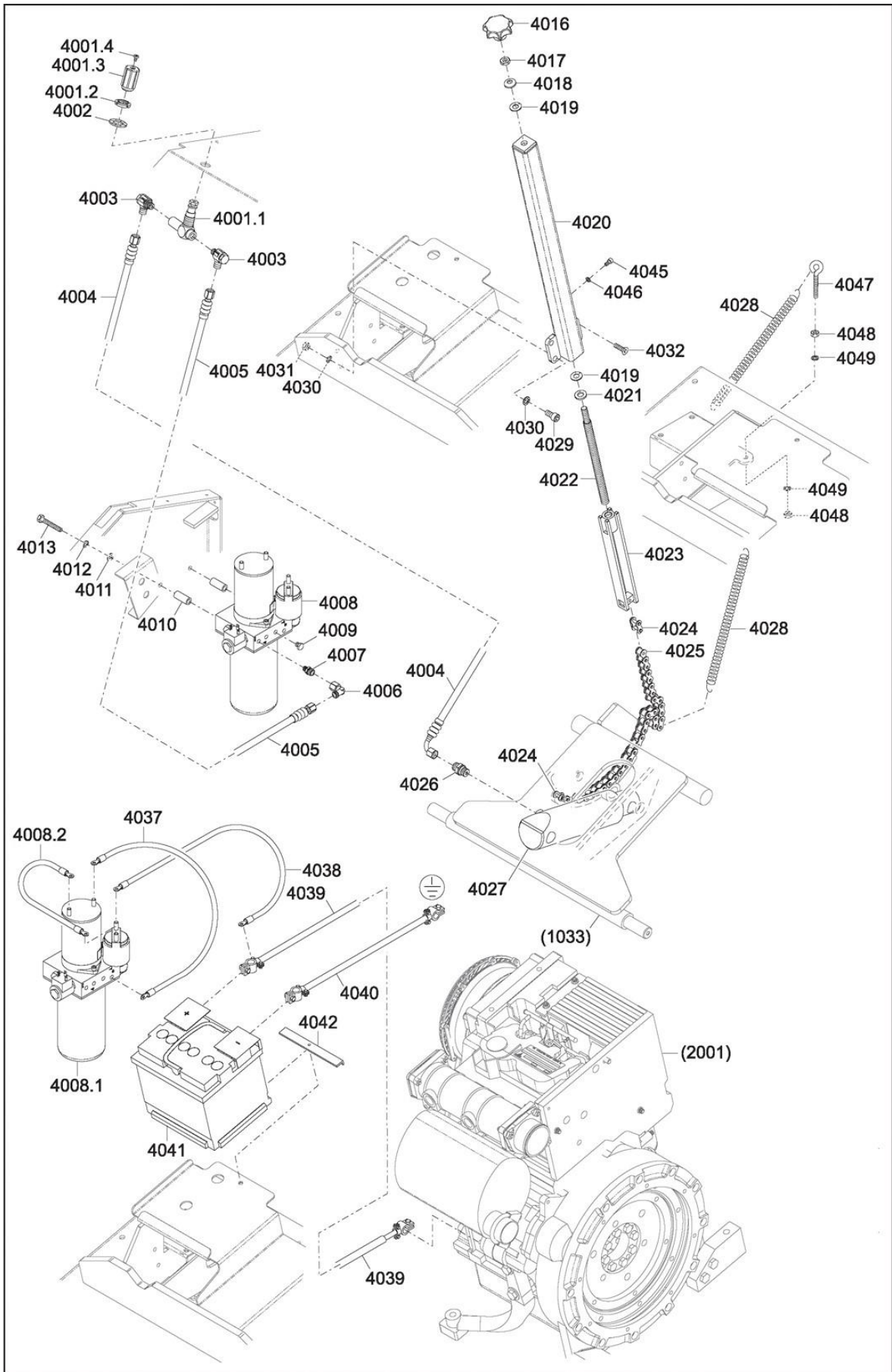

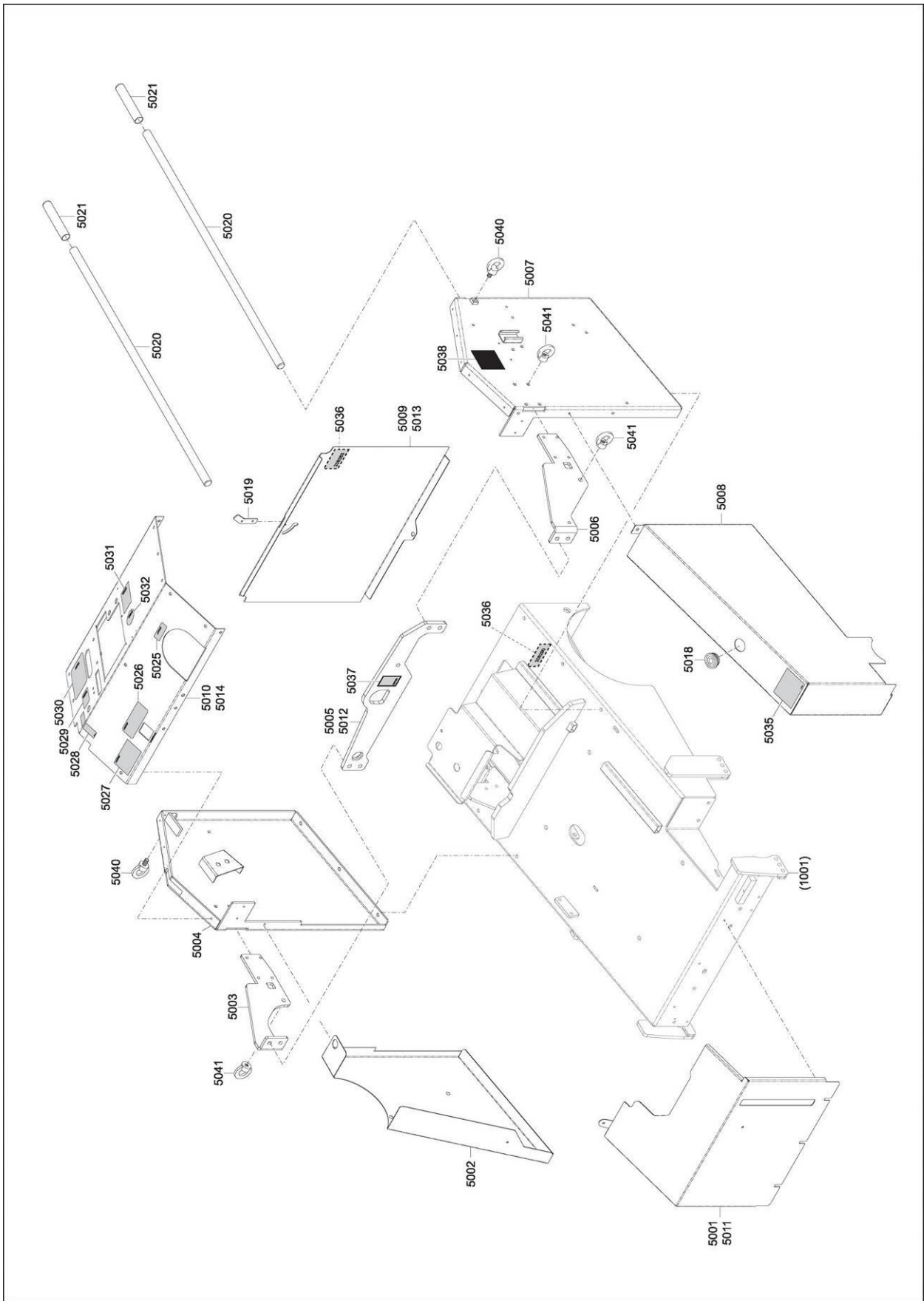

- 5015
- 5016
- 5017
- 5022
- 5023
- 5024
- 5033
- 5034
- 5039

6009
6010

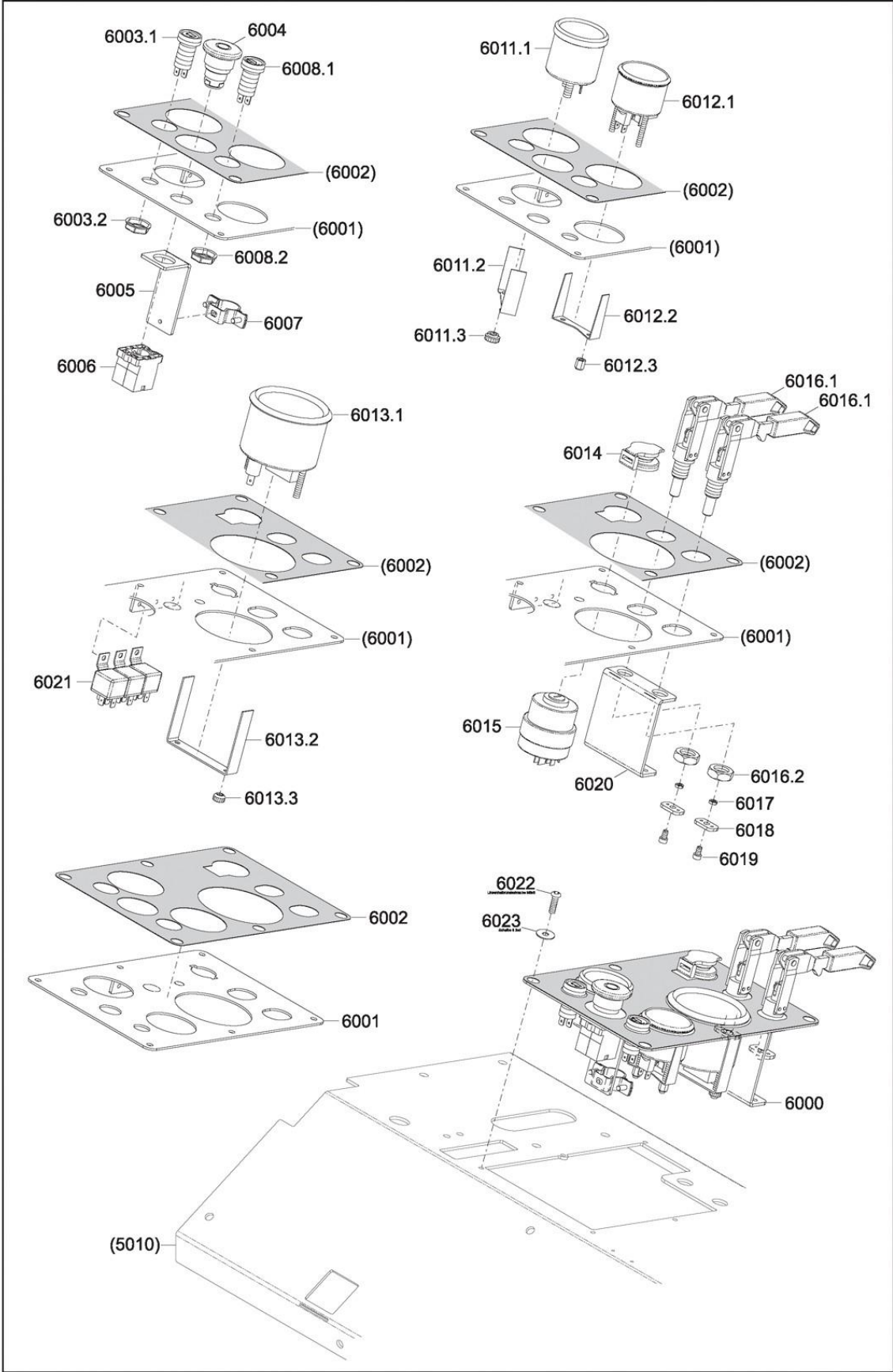

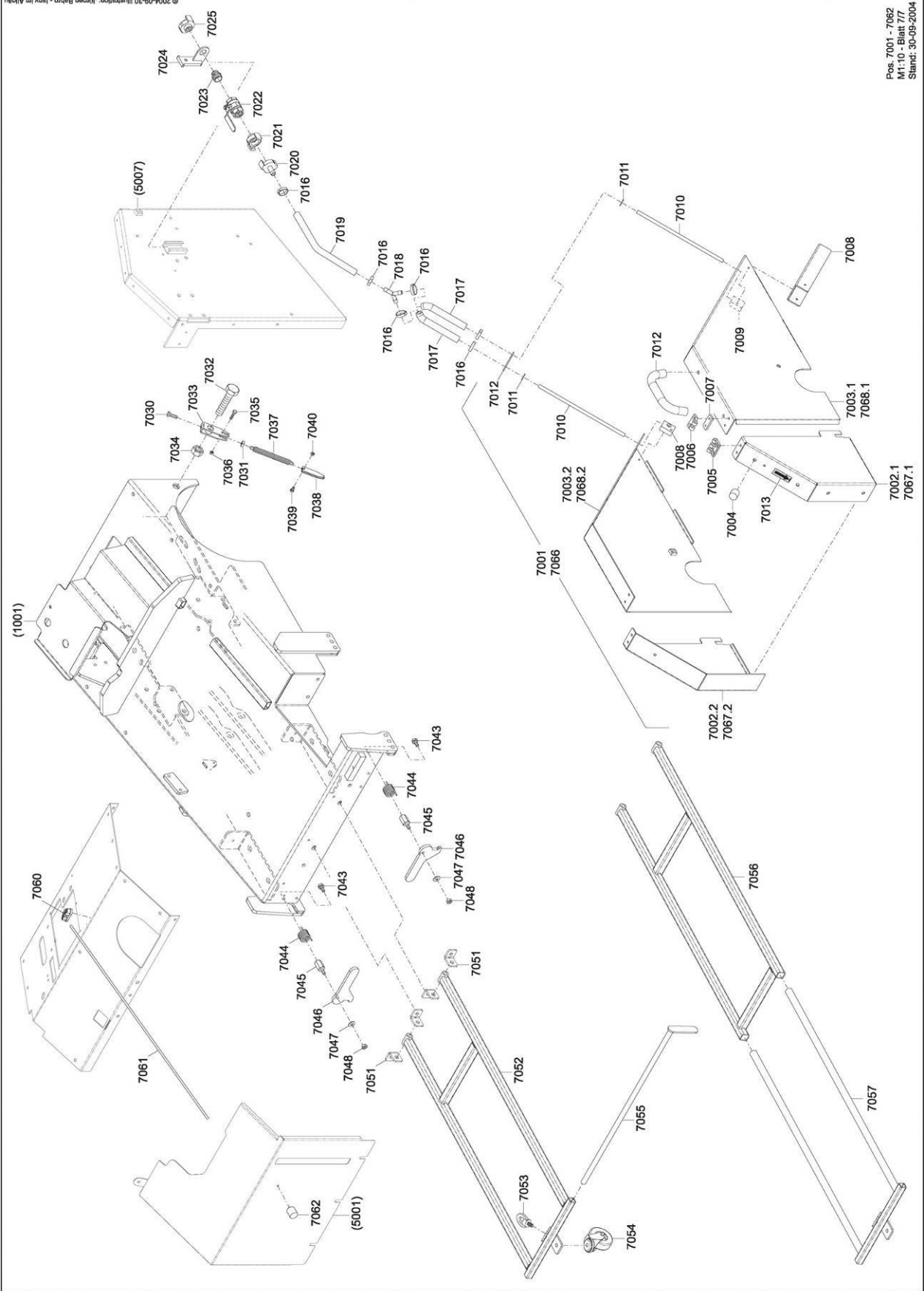

- 7013
- 7014
- 7015
- 7026
- 7027
- 7028
- 7029
- 7041
- 7042
- 7049
- 7050
- 7058
- 7059

www.construction.norton.eu

Saint-Gobain Abrasives

190, Bd. J. F. Kennedy
L-4930 BASCHARAGE
LUXEMBOURG

Tel: ++352 50401-1

Fax: ++352 501633

e-mail: sales.nlx@saint-gobain.com