

CMV 1000 Verto

OPERATING INSTRUCTIONS

Translation of the original Instructions





CE Declaration of conformity

The undersigned manufacturer:

SAINT - GOBAIN ABRASIVES S.A.
190, BD. J. F. KENNEDY
L-4930 BASCHARAGE

Declares that this product:

Compactors:

Code: **701846xxxx**

Is in conformity with the following Directives:

- **"MACHINES" 2006/42/CE**
- **"LOW VOLTAGE" 2014/35/UE**
- **"ELECTROMAGNETIC COMPTABILITY" 2014/30/UE**
- **"NOISE" 2000/14/CE**

And European standard :

- **EN 500-1** *Mobile road construction machinery. Safety - Part 1: Common requirements*
- **En 500-4** *Mobile road construction machinery - Safety - Part 4: Specific requirements for compaction machines*

Valid for machines as of serial number : 1801XXXXX

Storage site for the technical documents :

Saint-Gobain Abrasives 190, Bd. J. F. Kennedy 4930 BASCHARAGE, LUXEMBOURG

This declaration of conformity loses its validity when the product is converted or modified without agreement.

Bascharage, Luxembourg, le 15.05.2018 :

François Chianese, executive officer.

CMV 1000 Verto

OPERATING INSTRUCTIONS

TABLE OF CONTENTS

<u>1</u>	<u>BASIC SAFETY INSTRUCTIONS.....</u>	<u>7</u>
1.1	<i>Symbols</i>	7
1.2	<i>Machine plate.....</i>	9
1.3	<i>Safety instructions for particular operating phases</i>	9
<u>2</u>	<u>MACHINE DESCRIPTION.....</u>	<u>10</u>
2.1	<i>Short description</i>	10
2.2	<i>Purpose of use.....</i>	10
2.3	<i>Layout</i>	11
2.4	<i>Technical data.....</i>	15
2.5	<i>Statement regarding the vibration emission.....</i>	16
2.6	<i>Statement regarding noise emission</i>	17
<u>3</u>	<u>ASSEMBLY AND COMMISSIONING.....</u>	<u>18</u>
3.1	<i>Tool assembly.....</i>	18
3.2	<i>Electrical connections.....</i>	19
3.3	<i>Starting the machine.....</i>	19
3.4	<i>Water cooling system.....</i>	20
<u>4</u>	<u>TRANSPORT AND STORING</u>	<u>22</u>
4.1	<i>Securing for transport</i>	22
4.2	<i>Transportation procedure.....</i>	23
4.3	<i>Wheel kit (option).....</i>	24
4.4	<i>Long period of inactivity.....</i>	24
<u>5</u>	<u>OPERATING THE MACHINE</u>	<u>24</u>
5.1	<i>Jobsite.....</i>	24
5.2	<i>Cutting methods</i>	25
<u>6</u>	<u>MAINTENANCE AND SERVICING</u>	<u>27</u>
<u>7</u>	<u>FAULTS : CAUSES AND CURES</u>	<u>28</u>
7.1	<i>Fault-finding procedures</i>	28
7.2	<i>Trouble-shooting guide</i>	28
7.3	<i>Circuit Diagram 400V.....</i>	29
7.4	<i>Roller table (option).....</i>	30
7.5	<i>Customer service.....</i>	35
7.6	<i>Spare parts.....</i>	36









1 BASIC SAFETY INSTRUCTIONS

The CMV 1000 Verto is exclusively designed for the cutting of construction products mainly on construction sites.

Uses other than the manufacturer's instructions shall be considered as contravening the regulations. The manufacturer shall not be held responsible for any resulting damage. Any risk shall be borne entirely by the user. Observing the operating instructions and compliance with inspection and servicing requirements shall also be considered as included under use in accordance with the regulations.

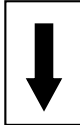
1.1 Symbols

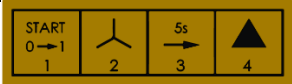
Important warnings and pieces of advice are indicated on the machine using symbols. The following symbols are used on the machine:

 <p>Before using the machine read the operating instructions</p>	 <p>Wear gloves</p>
 <p>Wear ear protection</p>	 <p>Wear safety glasses</p>
 <p>Never touch the diamond saw blade during running!</p>	 <p>Rotating direction of the saw blade</p>
 <p>If, you do not use the machine lock the feed mechanism in any time</p>	 <p>Pay attention to the short manual before switching ON the machine</p>
 <p>Use only the integrated crane hook if you lift up the machine with crane equipment!</p>	 <p>For dry cutting (in exceptionally cases) wear additional dust mask</p>



1.2 Machine plate

Important data can be found on the following plate located on the machine :

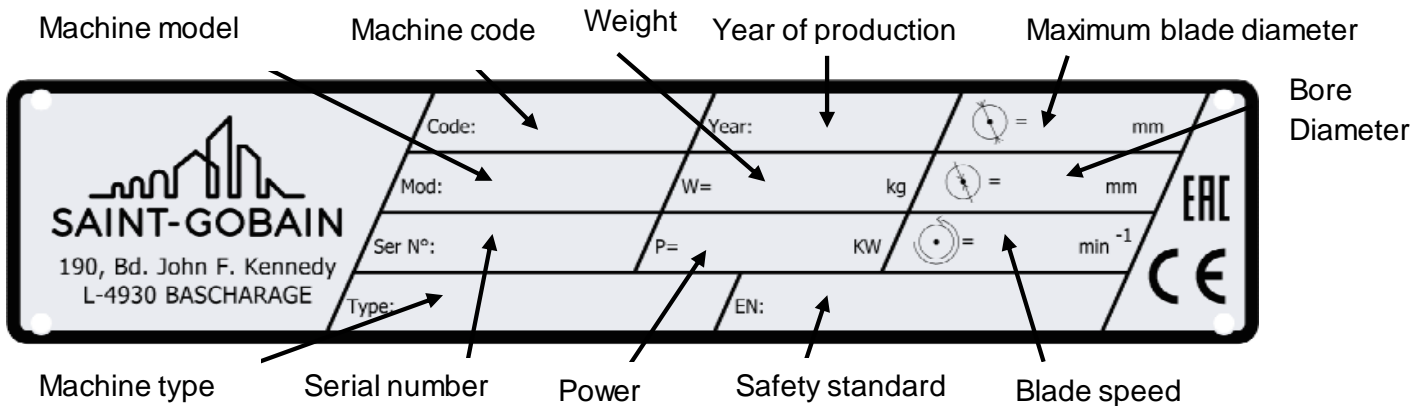

1.3 Safety instructions for particular operating phases

Before starting the work

- Before commencing work, make yourself familiar with the working environment at the place of use. The working environment includes: obstacles in the area of work and manoeuvre, the firmness of the floor, necessary protection at the site relating to public thoroughfares and the availability of help in the event of accidents.
- Check for correct mounting of the blade regularly.
- Immediately remove damaged or badly worn blades, as they endanger the operator whilst rotating.
- The material to be cut must be held securely in place on the cutting table allowing no movement during cutting operation.
- Always cut with the blade guard in position.
- Only fit NORTON diamond blades to the machine! The use of other tools can damage the machine!
- Read the blades' specifications carefully to choose the correct tool for your application.
- Attention is drawn to the use of BS2092 safety goggles in conformity with specified Processes No.8 of the Protection of Eyes Regulation 1974, Regulation 2(2) Part 1. and additional dusk mask for dry cutting (only in exceptionally cases).
- Do not force on the hand wheel if the blade does not come down. If the blade does not come down, please handle as follows to avoid any risk of injury for the operator or damages on the machine: Block the cutting head against accidental lowering, disconnect the machine from the power supply and inspect the inside of the machine/bladeguard. The cutting head could be blocked by mud generated during cutting, if so, remove the mud and clean the machine. It is

mandatory to clean the machine (inside and outside) after each use and before the mud dries (as mentioned in manual). Before continue to work please check if cutting head and feed is smooth. If not identify and repair issues like bended parts or foreign matters. If the problem remains, contact your Norton Clipper dealer.

While the engine is running

- Do not move the machine whilst the blade is running idle.
- Always cut with the blade guard in position.

Electrical powered machine

- Always turn off the machine and separate it from the main source of electricity before any work on the machine is done.
- You can lock the ON-OFF (0 – I) switch using a padlock.
- Make all electrical connections securely to eliminate contact of live wires with spray water or dampness
- It is **IMPERATIVE** that you earth the machine properly.
- Shut down the machine immediately in case of danger.
- In the event of the machine breaking down or stopping for no apparent reason, switch off the main electricity supply. Only a qualified electrician is allowed to investigate the trouble and remedy the fault.

2 MACHINE DESCRIPTION

Any modification, which could lead to a change in the original characteristics of the machine, may be done only by Saint-Gobain Abrasives who shall confirm that the machine is still in conformity with the safety regulations.

2.1 Short description

The CMV 1000 Verto vertical saw is designed for durability and high performance for onsite wet and dry cutting operations of a wide range of masonry, refractory and natural stone products.

As with all other NORTON products, the operator will immediately appreciate the attention given to detail and quality of materials used in construction. The machine and its component parts are assembled to high standards assuring long life and minimum maintenance.

2.2 Purpose of use

The machine is designed for cutting a large range of building and refractory materials. It is not designed for cutting wood or metals.

2.3 Layout

Frame (1)

Jig-welded, reinforced and all-steel construction ensures perfect rigidity. The frame includes a large capacity water tray (2) with drain plug. Frame has a built-in steel pallet (3) which meets a norm European pallet and a fork lift bracket (4). Also, a crane hook is integrated into the frame and can be lifted out if its needs (5).



***11 and 12 In option**

Electrical Motor and switch (6)

Motor with 7,5kW: Low voltage trigger (NVR) prevents the motor to restart for example after a power cut.

The electric motor has overload protection. Thermal overload tripping can occur for two reasons:

- a. tripping under light load
 - If connection is incorrect
 - If a phase is not under load

Check the connections and the phase voltage before restarting the machine.

- b. tripping under heavy load
 - If motor has been overloaded

The ON-OFF switch also serves as emergency stop.

Cutting head

Jig-welded steel console housed in a heavy-duty bearing. Console supports the electric motor, the chain drive with its guard and the blade shaft assembly. Precision-machined blade shaft held in ball bearings and is driven by a chain. The blade shaft assembly is completely enclosed in a cutting head console, accessible for inspection by opening the blade guard. The removable blade flange is tightened by means of a hexagonal nut. The spring-loaded cutting head ensures smooth lowering of the cutting head and automatically drive the cutting head up. The movement of the head is ensured by a handwheel (7) which is integrated in the machine cover and cannot be damaged during transportation. The head can be locked by a lock pin (8).

Cutting table

Large, heavy-duty and solid table fitted with wide water flow-control vents. The table is equipped with a backstop and with a guide-a-cut device. The CMV 1000 Verto is supplied with a flat table (9) and an integrated swivel table (10). A roller table is optional available.

Water cooling system

A powerful submersible electric water pump (13) which is placed in the water tray provides the water to the cutting diamond saw blade. Two water nozzles located in the saw blade guard ensure adequate flow of water to both sides of the diamond saw blade. The water tap (14) permitting controlled water flow. The large size water tray (2) is supplied with a drain plug (15). The water tray can be pulled out for cleaning.

Dry cutting (only in exceptionally cases)

In exceptionally cases the CMV 1000 Verto can be used for dry cutting. For the suction of the cutting dust the vacuum adapter (16) can be used in combination of a dry vacuum cleaner.

Blade guard

Jig-welded steel construction with 1000mm diameter saw blade capacity, which offers maximum operator protection and increased visibility of the work piece. The blade guard can be opened by two pieces (18), which permits easy access to shaft for inspection and blade replacement when motor is switched off. The direction of the saw blade rotation is pointed out with an arrow at the front blade guard (19). For the replacement of the saw blade you may use the inclusive universal wrench (20).

Wheel kit (option)

For the CMV 1000 Verto a complete wheel kit is optional available (the wheel kit can be ordered and self-assembled separately). The wheel kit includes one front joke wheel (21) and two back wheels (22). With this wheel kit the machine can be moved around the working place. If, the wheel kit is not in use you may place it in the plug-in slots.

Roller table (option)

The CMV 1000 Verto is available with an optional roller table. The optional roller table kit comes with a hydraulic pump (11) together with two roller tables (12) and all needed hydraulic components.

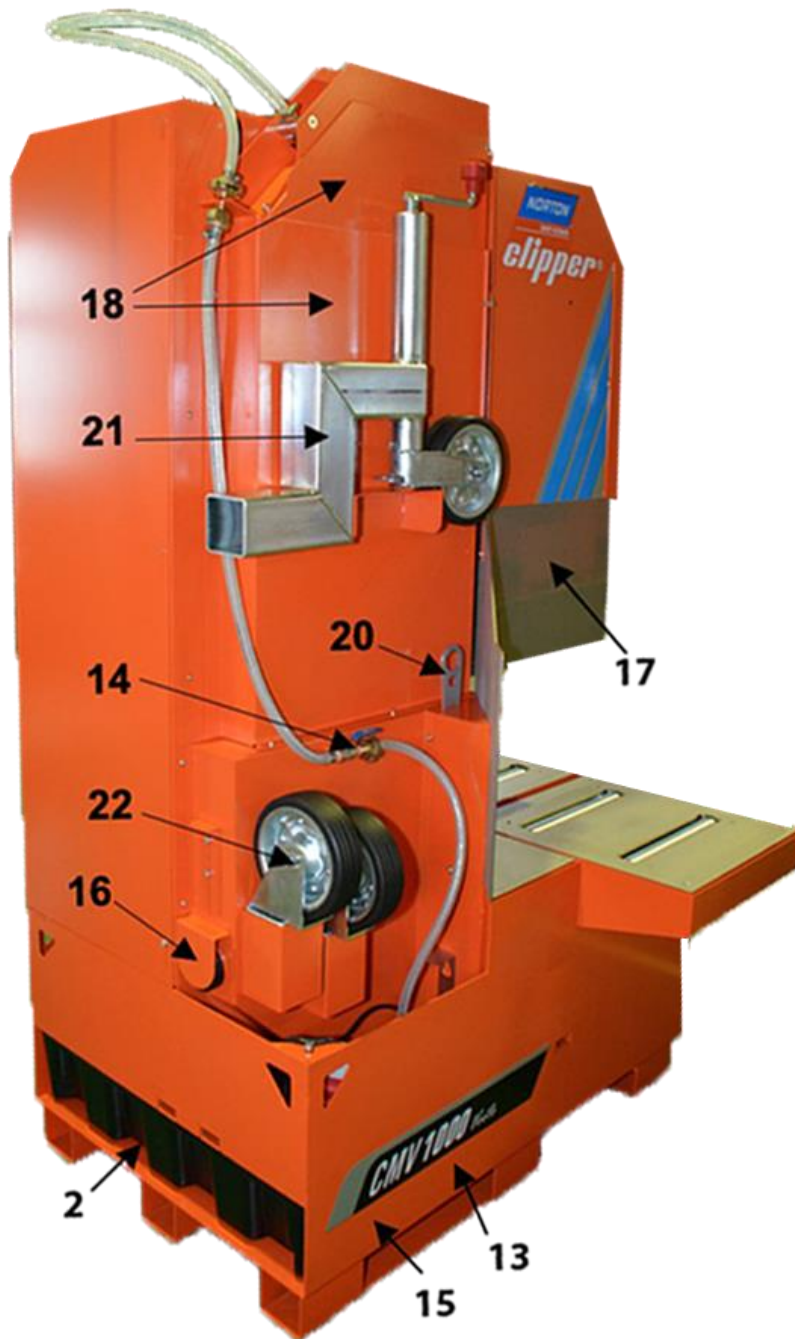

***21 and 22 in option**

2.4 Technical data

	CMV 1000 Verto
Electric motor	7,5kW / 14.5A / 50Hz / 2900 1/min. / IE3
Voltage	400V / 3-Phase / CEE 32
Electric motor protection	IP55
Switch	Star-triangle switch with thermal overload protection, no volt release and emergency stop
Max. saw blade diameter	1000 mm
Saw blade shaft diameter	60 mm
Cutting height max.	650 mm
Cutting depth max. (without swiveling the material)	420 mm
Table width	1050 mm
Flange diameter	150 mm
Blade shaft speed	900 1/min.
Machine dimension (l/w/h)	1200/800/1995mm
Weight	583 kg
Weight max.	628 kg
Sound pressure level	88 dB (A) following ISO EN 11201
Sound energy level	99 dB (A) following ISO EN 3744

2.5 Statement regarding the vibration emission

Declared value of vibration emission following **EN 12096**.

Machine Model / code	Measured value of vibration emission at m/s ²	Uncertainty K m/s ²	Tool used Model / code
CMV 1000 Verto Full Version 400V 70184603244	<2.5	0.5	Norton universal laser
CMV 1000 Verto Basic Version 400V 70184603243			
CMV 1000 Verto Hydraulic table 400V 70184607717			

- The vibration value is lower and does not exceed 2.5 m/s².
- Values determined using the procedure described in the standard **EN 12418**.
- The measurements are made with new machines. Actual values may vary with site conditions, in terms of:
 - Materials worked
 - Wear Machine
 - Lack of maintenance
 - Inappropriate tool for application
 - Tool in poor condition
 - Unskilled operator
 - Etc...
- The exposure time to vibration is based on the performance of work (related to the adequacy Machine / Tool / worked material / operator)

When evaluating risks due to hand-arm vibration, you need to take into account effective usage at rated power of machine during a full day of work; quite often you will realize that effective utilization time represents around 50% of overall duration of work. You have to consider, of course, breaks, water feeding, preparation of work, time to move the machine, disk mounting...

2.6 Statement regarding noise emission

Declared value of noise emission following **EN ISO 11201** and **NF EN ISO 3744**.

Machine Model / code	Sound Pressure level L_{Peq} EN ISO 11201	Uncertainty K (Sound Pressure level L_{Peq} EN ISO 11201)	Sound power level L_{Weq} NF EN ISO 3744	Uncertainty K (Sound power level L_{Weq} NF EN ISO 3744)
CMV 1000 Verto Full Version 400V 70184603244	86 dB(A)	2.5 dB(A)	100 dB(A)	4 dB(A)
CMV 1000 Verto Basic Version 400V 70184603243				
CMV 1000 Verto Hydraulic table 400V 70184607717				

- Values determined using the procedure described in the standard **EN 12418**.
- The measurements are made with new machines. Actual values may vary with site conditions, in terms of:
 - Wear Machine
 - Lack of maintenance
 - Inappropriate tool for application
 - Tool in poor condition
 - Unskilled operator
 - Etc...

Measured values relate to an operator in normal use, as described in the manual position.

3 ASSEMBLY AND COMMISSIONING

The machine is delivered fully equipped and assembled and is ready for operation after connection to the appropriate power supply.

3.1 Tool assembly

Only NORTON blades with a maximum diameter of 1000mm can be used with the CMV 1000 Verto. All tools must be selected with regard to their maximum permitted cutting speed for the machine's maximum permitted rotation speed. Before mounting a new blade into the machine, switch off the machine and isolate it from the main source of electricity.



To mount a saw blade, follow these steps:

- Lift up the saw blade respectively the blade guard by the hand wheel in the middle position and secure it by using of the lock pin
- Disassemble the water fitting on the middle and the above blade guard (I.)
- To remove the ratchet screw and the blade shaft hexagon nut use the included universal wrench
- Remove the ratchet screw at the middle blade guard (II.)
- Disassemble the middle blade guard
- Remove the ratchet screw at the upper blade guard (III.)
- Disassemble the upper blade guard
- Remove the outer water nozzle from the water quick coupling (IV.)
- Disassemble the blade shaft hexagon nut (attention: left-hand thread) and the outer saw blade flange (V.)
- Clean the flanges and blade shaft and inspect for wear
- Place the saw blade on saw blade shaft (VI.)
- The blade bore must correspond exactly to the diameter of the blade shaft
- Cracked or damaged bore is dangerous for the operator and for the machine
- **Attention:** Ensuring that direction of rotation is correct (according to the arrow at the blade guard). Wrong direction of rotation blunts the blade quickly
- Place outer saw blade flange.
- Tighten the blade shaft hexagon nut

Reassemble the saw blade guard back in position.

3.2 Electrical connections

Check, if

- the voltage/phase supply corresponds to the information indicated on the motor plate
- available power supply must have ground connection in conformity with safety regulations
- the connecting cables should have at least a 2.5mm²-section per phase

3.3 Starting the machine

Before, you connect the machine with the power net check if the star-triangle switch and the ON-OFF switch is OFF! Switch the ON-OFF switch to ON. Then switch the star-triangle switch on Y. The water pump begins to work. Wait until the blade reaches its maximum rotational speed, then turn the star-triangle switch on Δ. Please, pay attention to the short manual sticker before you turn ON the machine!

Direction of rotation

The direction of rotation is indicated on the blade guard by an arrow. If the direction of rotation does not correspond to the direction shown by the arrow, turn off first the machine by the star-triangle switch to 0 and then the ON-OFF switch to OFF. Reverse the motor polarity by turning the phase

inverter inside the male plug with a screwdriver.

Emergency Stop

The main ON-OFF switch can be used as an emergency stop switch!

3.4 Water cooling system

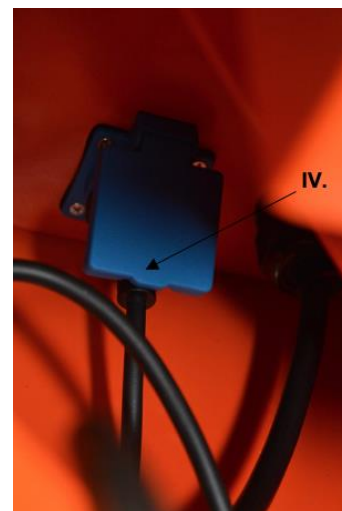

- Fill the water tray with clean water through the intake opening (I.) up to approximately 2cm from top (ensure that bottom of pump is fully immersed in water that the pump not run dry and burn)
- Make sure that the water pump plug is connected into the socket (II.) and the water hose connected to the pump
- Plunge the water pump basket down in the water tray (III.)
- The rotating saw blade has to be cooled on both side with enough water ... regulate the water flow with the water tap
- Ensure that water is flowing freely in the circuit and is delivered adequately to both sides of the saw blade, as insufficient water supply may result in premature failure of the diamond blade
- Do not run the water pump without water ... "dry running" will damage the water pump!
- Always make sure that there is enough water in the pan and refill if necessary
- In case of frost, empty the water management

Dry Cutting (only in exceptionally cases !)

- Make sure that you wear an additional dust mask and use dust vacuum collecting or cleaning equipment during dry cutting
- Pull out the water pump basket from the water tray and lock the water pump basket (I.)
- Pull the water pump plug out from the socket (II.)
- Lift up the vacuum adapter cover slider and plug in a dry vacuum cleaner hose (III.)
- You may use the „switched“ water pump socket for the dry vacuum cleaner. The ON/OFF function of the „switched“ socket will be „switched“ directly by the star-triangle switch

4 TRANSPORT AND STORING

Take the following measures in order to transport the CMV 1000 Verto securely.

4.1 *Securing for transport*

- As first empty the water tray
- Lift down the cutting head in its position that it is below the machine cover
- Secure the head using the locking pin and swivel in the hand wheel handle
- Swivel in the swivel table and secure it with the locking screw
- Make sure that the complete wheel kit is placed in the plug-in slots if you do not use it

Swivel table

ATTENTION: When swiveling the swivel table make sure that you are taking care to followings!

- **During swiveling the swivel table (1) has to be secured all times that it cannot falling down uncontrolled!**
- **The swivel table has to be secured with the locking screw (2) all the times!**
- **The locking screw has to be tightened always with the universal wrench (3)!**

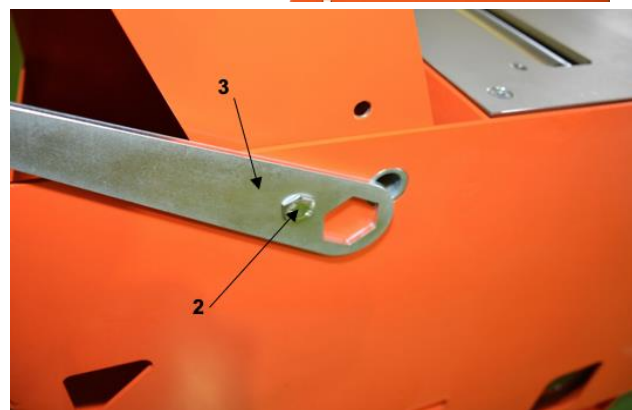
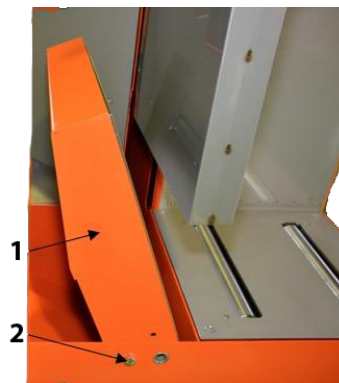

4.2 Transportation procedure



- Only use the crane hook (1) to lift the machine, as other parts of the machine are not designed for this purpose.
- If you want to transport the machine using a fork-lift truck, use the bracket (2) for one of the fork, the other one supporting under the frame
- You may use also a pallet jack for the integrated steel pallet to move around the machine

4.3 *Wheel kit (option)*



- The machine can be moved on a flat surface using its original wheel kit
- Insert the two back wheels on the back side of the machine into the outer European pallet feeds and the front jockey wheel at the front side of the machine in the middle pallet feed
- Turn the handwheel on the front jockey wheel until the third wheel touches the floor and raise the machine. The machine then leans on its three wheels. After the machine has been moved, on the floor, always lift the front jockey wheel using the handle

4.4 *Long period of inactivity*

If the machine is not going to be used for a long period, please take the following measures:

- Completely clean the machine
- Empty the water system
- Take the water pump out of the slurry and clean it thoroughly.

The storage site must be clean, dry and at a constant temperature.

5 OPERATING THE MACHINE

You will find in this chapter some advice about where and how to put up the machine.

5.1 *Jobsite*

Voici quelques renseignements concernant le site d'installation de la machine.

5.1.1 Siting the machine

- Remove from the site anything, which might hinder the working procedure!
- Site the machine on an even, firm and stable base!
- Make sure the site is sufficiently well lit!
- Observe manufacturer's conditions for connecting to power supplies!
- Place electric cables in such a way that damage by the device is excluded!
- Make sure you have a continual adequate view of the working area so you can intervene in the working process at any time!
- Keep other staff out of the area, so you can work securely.

5.1.2 Space required for operation and maintenance

Leave 2 m in front of the machine and 1,5 m around it for usage and maintenance of the CMV 1000 Verto.

5.2 Cutting methods

5.2.1 Preparing the cut

To prepare the cut the machine has turned OFF all the time, raise the head in its highest position and lock the cutting head.

- Place the bloc on the table
- Unlock the cutting head and turn the handwheel until the blade is just over the bloc
- Lock the cutting head
- Place your bloc precisely
- Raise the head in its highest position and lock the cutting head again

If, in your machine an optional roller table is integrated, you may pump up the rollers up with locked hydraulic valve at the manual hydraulic pump before you place the bloc on the table.

- Place the bloc on the rollers
- Unlock the cutting head and turn the handwheel until the blade is just over the bloc
- Lock the cutting head
- Place your bloc precisely
- Open the hydraulic valve at the manual hydraulic pump till the bloc is placed on the table
- Raise the head in its highest position and lock the cutting head again

5.2.2 The cut

To use the machine correctly, you must be on the side of the machine with one hand on the handwheel, and the other ready to stop the machine in case of emergency. Always keep your hands away from the moving blade. Switch on the machine. Lower the blade using the handwheel until you crosscut your bloc. Then raise the cutting head, and tighten it using the lever behind the handwheel. Then switch off the machine.

REMARK: turn the handwheel without undue pressure, especially if the material to be cut is very dense, in order not to damage the blade or the machine.

5.2.3 General advice for the cutting

- With the CMV 1000 Verto material weighing up to 350kg and max. dimensions of 420x650x1050mm can be cut
- Before commencing work make sure the diamond blade is firmly seated!
- Never touch the diamond saw blade during running!
- Select the right diamond blade as recommended by the manufacturer depending on the material to be worked, the working procedure (dry or wet cut) to be carried out and the required efficiency
- Apply cooling water continuously whilst cutting and in good time!
- If the thermal protection trips, wait a few minutes to allow the motor to cool down before restarting the machine.

6 MAINTENANCE AND SERVICING

To ensure a long-term quality from the cutting with the CMV 1000 Verto, please follow the maintenance plan below:

		Begin of the day	Replacement of the tool	End of the day	Every week	Every three months	After a fault	After a damage
Whole machine	Visual control (general aspect)							
	Clean							
Saw blade shaft and flange	Clean							
Water tray	Clean							
Water pump	Clean							
Water tab, -fittings, -hoses and -nozzles	Clean							
Blade guard	Clean							
Chain hoist base plate	Clean							
Motor housing and cooling fins	Clean							
Reachable nuts and screws	Tighten up							
Cutting head guide bar and rail	Grease							
Chain hoist	Grease							
Gear box	Oil level control							

Maintenance of the machine

Always perform the maintenance of the machine with the machine isolated from the electrical supply. To grease the bearing to the cutting head guide, to grease the chain hoist, control the oil level in the gear box and to clean the chain hoist base plate you have remove the chain hoist cover first. To remove the chain hoist cover you have to release the 7 pcs. of ratchet screws with the included universal wrench.

Cleaning of the machine

Your machine will last longer if you clean it thoroughly after each day of work, especially water pump, water pan, motor, blade flanges, cutting head guide bar and rail.

7 FAULTS : CAUSES AND CURES

7.1 *Fault-finding procedures*

Should any fault occur during the use of the machine, turn it off, and isolate it from the electrical supply. Any works dealing with the electrical system or supply of the machine can only be carried out by a qualified electrician.

7.2 *Trouble-shooting guide*

Trouble	Possible source	Resolution
Wrong direction of rotation	Wrong motor polarity	Invert polarity on male plug
Motor is not running	No electricity	Check the electrical supply (fuse for example)
	Connection cable section too small	Change connection cable
	Defective connection cable	Change connection cable
	Defective switch	CAUTION : can only be solved by qualified electrician
	Defective motor	Change motor or contact motor manufacturer
Motor stops during the cutting, but can be restarted after a short period	Cutting advance too quick	Cut slowly
	Blade is blunt or glazed	Sharpen the blade in calcareous stone
	Defective blade	Change blade
	Wrong blade corresponding to the application	Change blade
No water on the blade	Water tap is closed	Open tap on water pump
	Water tray empty	Fill up the water tray
	Water supply system is blocked up	Clean water supply system
	Water pump is not working	Turn the machine off and clean the pump thoroughly
	Water pump defective	Change the water pump

7.3 Circuit Diagram 400V

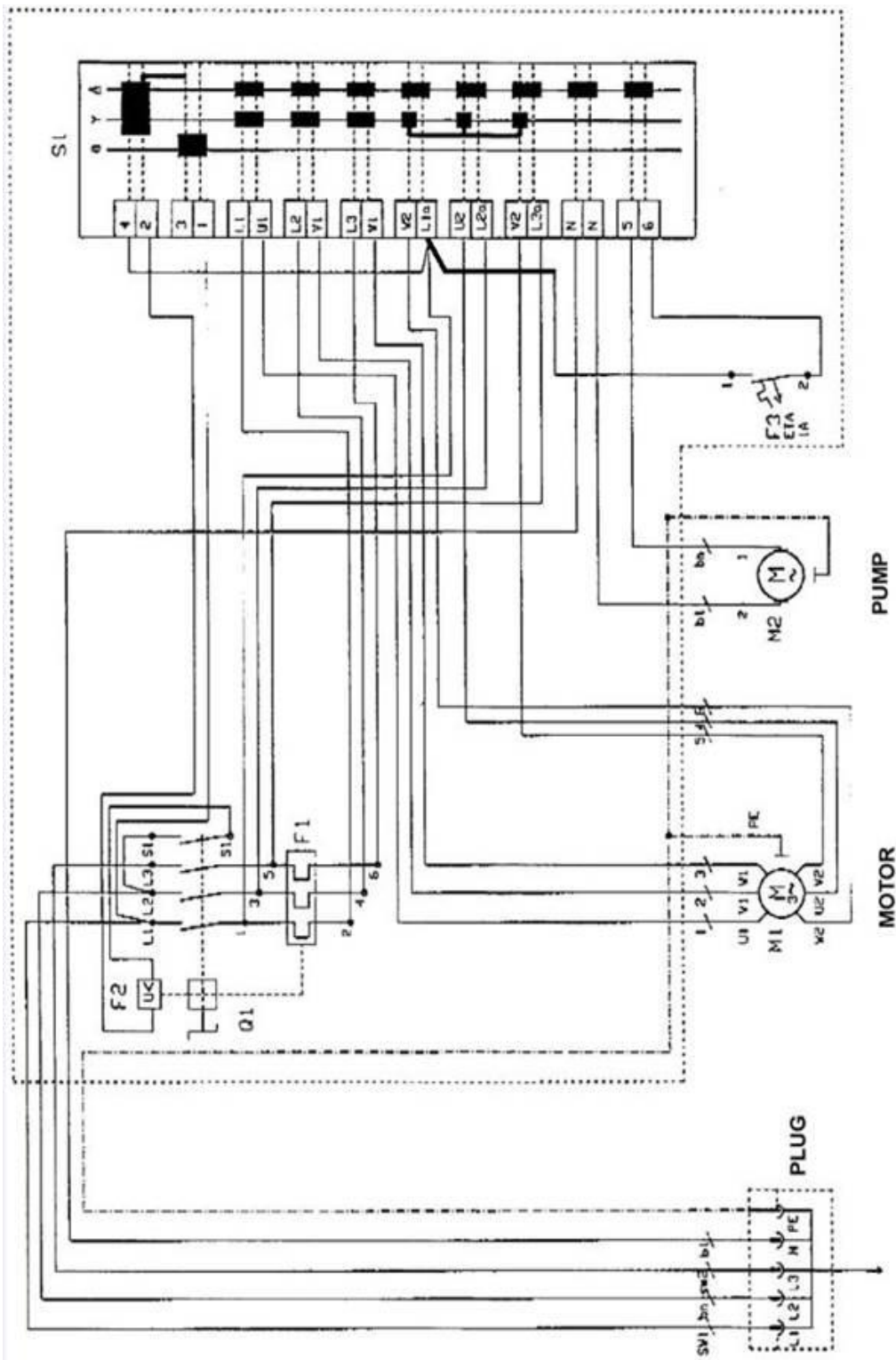

7.4 *Roller table (option)*

If, you have ordered later a complete roller table kit for your CMV 1000 Verto you may assembly it as following:

Step 1.: Remove first the black cover caps, insert the hydraulic hose through the bigger hole and assembling the manual hydraulic pump with the included screws



Step 2.: Release the table screws, pull out the table plate and remove the last black cover cap

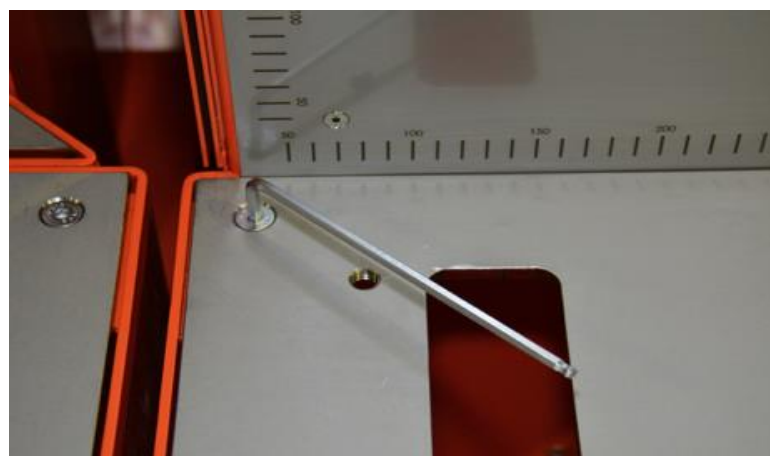

Step 3.: Insert the hydraulic hose next to the chain hoist through the bigger hole into the water collecting housing. Insert the additional hydraulic hose with the side of 700mm through the hole to the water collecting housing of the swivel table. Connect the T-fitting with the hydraulic hose (quick coupling).

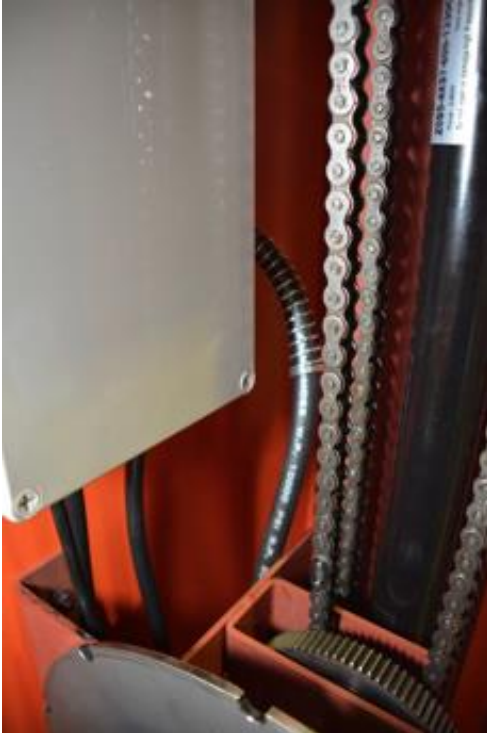

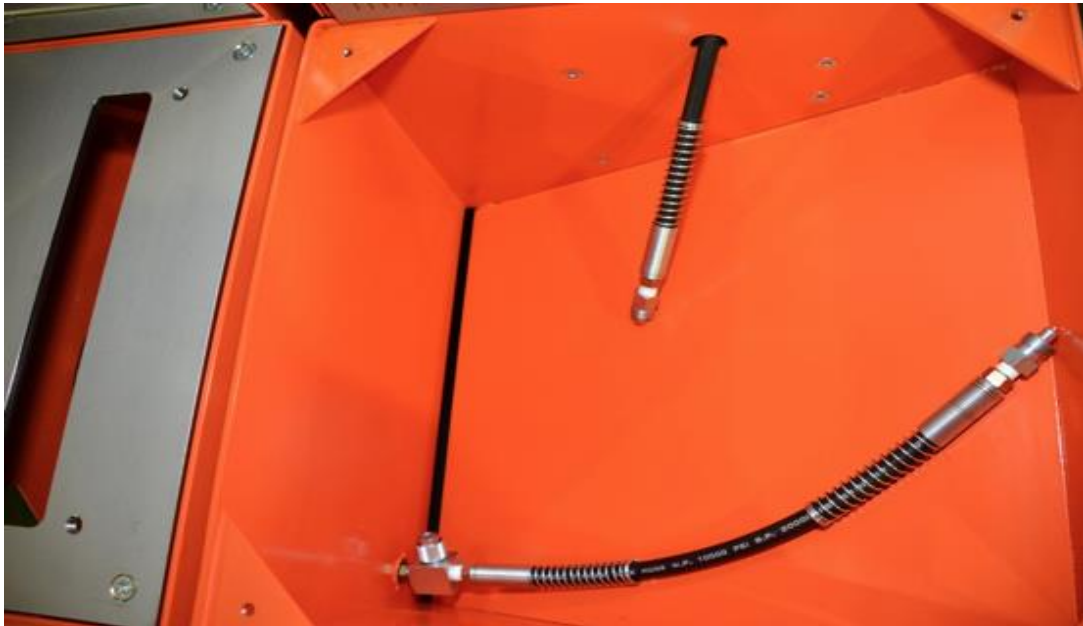

Step 4.: Release the transport secure screws at the roller tables and assemble them at the table plates from the bellow side.

Caution: The quick fix coupling at the hydraulic cylinders have to be placed in the direction of the front side of the machine (see at picture step 5.)



Step 5.: Place the table plates again and connect the hydraulic hoses with the hydraulic cylinders

(quick fix couplings).



Step 6.: Finish the assembling of the roller table kit with tightening of the table screws. Now, you may continue with the placement of the bloc according to the point 5.2.1 Preparing the cut with roller table.

Caution: The manual hydraulic pump has an integrated pressure limiter what means you may use the manual hydraulic pump as long as the rollers reach the final position ... if, you continue with pumping the hydraulic pump the hydraulic system is secured any time!

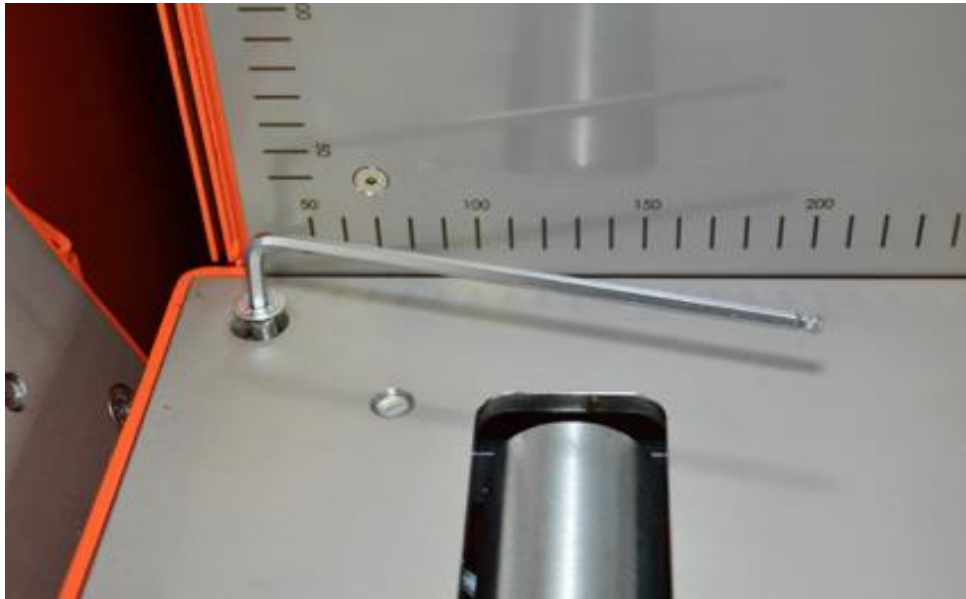

7.5 *Customer service*

When ordering spare parts, please mention:

- The serial number (7 digits).
- The code of the part.
- The exact denomination.
- The number of parts required.
- The delivery address.
- Please indicate clearly the means of transportation required such as "express" . Without specific instructions, we will forward the parts through the means which seem appropriate to us --- but which is not always the quickest way.

Clear instructions will avoid problems and faulty deliveries.

If not sure, please send us the defective part.

In the case of a warranty claim, the part must always be returned for evaluation.

This machine has been manufactured by: Saint-Gobain Abrasives S.A.:

190, Bd. J. F. Kennedy

L-4930 BASCHARAGE

Grand-duché de Luxembourg

Tel. : 00352 50 401 1

Fax. : 00331 83717792

<http://www.construction.norton.eu>

e-mail : sales.nlx@saint-gobain.com

7.6 Spare parts

In order to consult the spare parts lists, we invite you to visit the after-sales website of Norton Clipper by using the following address:

<https://spareparts.nortonabrasives.com>

For a quick access, you can also use the QR Code shown below using your mobile phone:



This electronic catalogue provides exploded views and spare parts lists for different machines designed by Norton Clipper so you can find references you need.

Guarantee can be claimed and technical support obtained from your local distributor where machines, spare parts and consumables can be ordered as well:

SAINT-GOBAIN ABRASIVES NV/SA
INDUSTRIELAAN 129
1070 ANDERLECHT/BRUSSEL
BELGIUM
TEL: +32 (0)2 267 21 00
FAX: +32 (0)2 267 84 24

SAINT-GOBAIN ABRASIVES, S.R.O.
POČERNICKÁ 272/96, MALEŠICE
108 00 PRAHA 10
CZECH REPUBLIC
TEL: +420 255 719 326
FAX: +420 255 719 321

SAINT-GOBAIN ABRASIVES A/S
ROBERT JACOBSENS VEJ 62A
2300 KØBENHAVN S
DENMARK
TEL: +45 4675 5244

PO BOX 643706
FORTUNE TOWER OFFICE 2106
JLT BLOCK C
(NEXT TO METRO STATION)
JUMEIRA LAKE TOWER, DUBAI
UNITED ARAB EMIRATES
TEL: +971 4 431 5154
FAX: +971 4 431 5434

SAINT-GOBAIN ABRASIFS
RUE DE L'AMBASSADEUR - B.P.8
78 702 CONFLANS CEDEX
FRANCE
TEL: +33 (0)1 34 90 40 00
FAX: +33 (0)1 39 19 89 56

SAINT-GOBAIN ABRASIVES GMBH
BIRKENSTRASSE 45-49
D-50389 WESSELING
GERMANY
TEL: +49 (0) 2236 703-1
+49 (0) 2236 8996-0
+49 (0) 2236 8911-0

FAX: +49 (0) 2236 703-367
+49 (0) 2236 8996-10
+49 (0) 2236 8911-30

FÜR DEN FACHHANDEL
ÖSTERREICH
TEL: +43 (00) 662 430 076

SAINT-GOBAIN ABRASIVES KFT.
1225 BUDAPEST
BÁNYALÉG U. 60/B.
HUNGARY
TEL: +36 1 371 22 50
FAX: +36 1 371 22 55

SAINT-GOBAIN ABRASIVI S.P.A
VIA PER CESANO BOSCONI 4
I-20094 CORSICO MILANO
ITALY
TEL: +39 02 44 851
FAX: +39 02 44 78 266

SAINT-GOBAIN ABRASIVES S.A.
190 RUE J.F. KENNEDY
L-4930 BASCHARAGE
GRAND DUCHE DE LUXEMBOURG
TEL: +352 50 401 1
FAX: +331 83 717 792
NO. VERT (FRANCE) 0800 906 903

SAINT-GOBAIN ABRASIFS, S.A.
2 ALLÉE DES FIGUIERS
AIN SEBAË - CASABLANCA
MOROCCO
TEL: +212 5 22 66 57 31
FAX: +212 5 22 35 09 65

SAINT-GOBAIN ABRASIVES BV
GROENLOSEWEG 28
7151 HW EIBERGEN
P.O. BOX 10
7150 AA EIBERGEN
THE NETHERLANDS
TEL: +31 545 466466
FAX: +31 545 474605

SAINT-GOBAIN ABRASIVES AS
POSTBOKS 11, ALNABRU,
0614 OSLO
BROBEKKVEIEN 84,
0582 OSLO
NORWAY
TEL: +47 63 87 06 00
FAX: +47 63 87 06 01

SAINT-GOBAIN HPM POLSKA SP. Z O.O.
UL. NORTON 1
62-600 KOŁO
POLAND
TEL: +48 63 26 17 100
FAX: +48 63 27 20 401

SAINT-GOBAIN ABRASIVOS, L. DA
ZONA INDUSTRIAL DA MAIA
I-SECTOR VIII, NO. 122
APARTADO 6050
4476 - 908 MAIA
PORTUGAL
TEL: +351 229 437 940
FAX: +351 229 437 949

SAINT-GOBAIN GLASS
BUSINESS UNIT ABRASIVI
PUNCT DE LUCRU: LOC.VETIS, JUD.
SATU MARE 447355
STR. CAREIULUI 11
PARC INDUSTRIAL RENOVATIO
ROMANIA
TEL: 0040-261-839.709
FAX: 0040-261-839.710

SG HPM RUS
58, F. ENGELS STR.
STROENIE 2
105082 MOSCOW
RUSSIA
TEL: +74 955 408 355
FAX: +74 959 373 224

SAINT-GOBAIN
ABRASIVES (PTY) LTD
2 MONTEER ROAD
ISANDO 1600
P.O. BOX 67
SOUTH AFRICA
TEL: +27 11 961 2000
FAX: +27 11 961 2184/5

SAINT-GOBAIN ABRASIVOS, S.A.
CTRA. DE GUIPÚZCOA, KM. 7,5
E-31195 BERRIOPLANO (NAVARRA)
SPAIN
TEL: +34 948 306 000
FAX: +34 948 306 042

SAINT-GOBAIN ABRASIVES AB
BOX 495
SE-191 24 SOLLENTUNA
SWEDEN
TEL: +46 8 580 881 00
FAX: +46 8 580 881 01

SAINT-GOBAIN INOVATIF
MALZEMELER VE AŞINDIRICI
SAN. TIC. A.Ş.
GOLD PLAZA, ALTAY ÇEŞME
MAHALLESİ, ÖZ SOKAK, NO:19/16
34843 MALTEPE-ISTANBUL,
TURKEY
TEL: 0090-216-217 12 50
FAX: 0090-216-442 40 74

SAINT-GOBAIN ABRASIVES LTD.
DOXEY RD
STAFFORD
ST16 1EA
UNITED KINGDOM
TEL: +44 1785 222 000
FAX: +44 1785 213 487

