

NORTON

SAINT-GOBAIN®

clipper®

The CLIPPER Solutions







**TECHNICAL
SUPPORT**

1 Conseils de sécurité fondamentaux

La CS1 est exclusivement destinée à la coupe de sols en asphalte, en béton frais ou vieux (armé ou non), ainsi qu'en ciment pour sols. Une utilisation autre - ou élargie -, contraire aux conseils du fabricant, sera considérée comme non-conforme. Les dommages en résultant ne pourront incomber au fabricant. Le risque en sera exclusivement pris par l'utilisateur. L'utilisation conforme aux prescriptions comprend également le respect de la notice d'utilisation et des conditions de contrôle et d'entretien.

1.1 Pictogrammes

Des conseils et mises en garde sont représentés par des pictogrammes sur la machine. Vous trouvez les symboles suivants sur la CS1. Voici leur explication.

 Lire le manuel d'utilisation avant d'utiliser la machine	 Port de protections auditives obligatoires
 La rotation du volant dans le sens indiqué (UP) ou descend (DOWN) la lame	 Ne pas déplacer la machine avec la lame en rotation libre
 Arrêt d'urgence	 Sens de rotation du disque
 Danger: risque de coupure	

1.2 Plaquette machine

Vous pouvez trouver des informations sur la machine :

Modèle de machine Code Machine



Type Machine Numéro

1.3 Conseils de p

Avant le début des

- Familiarisez-vous

travail compris

respect des

rapport à

d'accéder

Vérifiez

Démontez

Ne pas

V





TILE SAWS Clippy's advice



> Never force the cutting and allow the blade and the motor torque of the machine to do the work

- Make sure the water pump is properly immersed before the use.
- Clean the water pump and the water tray right after the use to avoid the formation of a solid deposit, to work in full safety and increase the lifespan of the machine.
- On tile saws, make sure that the dividing knife (blade guard support) is properly aligned with the diamond blade to avoid the blocking and the break-in of the tiles.
- Always slow down the infeed speed at the end of the cut to avoid breaking the tile and to obtain a satisfactory quality of cut.

For optimum results, we recommend that you equip your Clipper machines with Norton diamond blades, designed specially for wet cutting of tiles.



TT180 BM table tile saw.



MASONRY SAWS Clippy's advice



> Cutting methods

• Full depth or fixed cutting

In full depth or fixed cutting, the cutting head is locked in a fixed position and the material is pushed into it as shown.

This technique usually provides greater efficiency than merely holding the head down. It works well with wet diamond blades cutting some soft materials. It is less efficient overall than the "Step Cutting" method for most materials, especially when using abrasive blades.

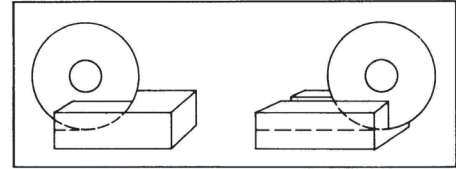

• Multiple step cutting

Multiple step cutting consists of moving the conveyor cart with the material to be cut back and forward under the rotating blade.

- Place the material to be cut on the conveyor cart firmly against the guide-a-cut and the backstop, keeping the hands well away from the blade.
- Start the machine.
- Move conveyor cart forward near the blade and pull down the cutting head until blade is lowered to a point where it will lightly contact the surface of the material.
- Pass the material beneath with rapid full length strokes, taking a shallow cut (approximately 3mm deep as shown on the picture) on the forward. On the backward stroke, lift the blade just clear over the cutting line.
- Complete each rapid stroke backward and forward by passing the material beyond the centre of the blade before starting the reverse movement of the conveyor cart.

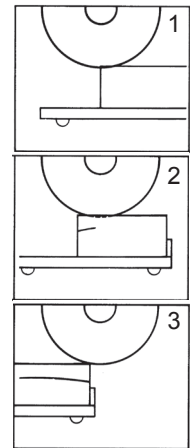

NOTE: the harder the material, the more rapid should be the forward and backward strokes.

Step cutting lessens the area of the blade circumference in contact with the material, keeping the blade cool, running free and cutting at peak efficiency.

- Be sure the water pump is plugged into the connection on the masonry saw motor. Make sure the water pump is on before starting a wet-cutting operation.
- Handle on petcock should be turned in line with the water flow. Start motor and be certain that both sides of the blade are getting an adequate flow of water.
- At all times make sure that the water level covers the screen on the bottom of the pump. Do not let sludge and dirt get deep enough in the pan to block the pump inlet.
- Clean the water-tray and the pump after use.
- Adapt the feed speed applied on the diamond blade and the depth of cut to prevent over-heating and failure of the motor.





FLOOR SAWS Clippy's advice



> Blade selection and mounting

Make sure that the diamond blade specification is selected according to the material to cut and to the power of the machine. Before mounting any blade on the saw, the blade should be inspected for any damage that might have occurred during shipment, handling or previous use.

The blade must be properly fitted over shaft and drive pin. Drive pin must project through hole in blade and into collar. Do not force the blade onto shaft.

The blade guard must always be in place when the saw is running. Always use a proper size blade guard for the size blade being used. The operator should wear safety glasses and appropriate safety equipment at all times.



> Machine maintenance and safety precautions

Total Daily Exposure (C)	< 2,5m/s ²	2,5m/s ² < DE < 5m/s ²	> 5m/s ²
Status	No action needed (D)	Employer must take actions to reduce or eliminate HAV	Employee must not work anymore

The EU Directive 2002/44/EC (the 'Vibration Directive') places responsibilities on employers to ensure that risks from hand-arm vibration are eliminated or reduced to a minimum. It also sets **maximum limits** to the daily exposure to hand-arm vibrations.

Each time you use brand new belts, check and set tension after 1 hour utilisation : poor tension setting is the main cause for early wear out of belts. Check regularly the air-filter, to preserve the life and performance of the engine.

Adequate coolant must be used when sawing with wet cutting diamond blades. An adequate coolant supply is required for wet cutting blades to maintain blade life and cutting efficiency.

If for any reason the blade stalls in the cut, raise the blade out of the cut and check the outside blade shaft collar and nut for tightness before restarting the engine. Inspect the blade for damage. Use care when resuming a cut. Make certain that the blade is in alignment with the previous cut.

Never leave a floor saw unattended while its engine is running. Always secure the saw from rolling when not in use. Operate the engine at the proper RPM. Never alter RPM or governor setting. In case of an EMERGENCY: "SHUT OFF ENGINE."



> Concrete or asphalt sawing methods

During cutting, do not exert excessive side pressure on the handles as a method of steering. Do not force the blade into material by lowering the blade too quickly or by increasing the speed of the saw.

The larger diameter blades, 450mm and above, are systematically used in a step cutting method at cutting depths of 5cm to 8cm in short travel distances of 15 to 20min. This allows the blade to remain in a free cutting condition and can allow for up to 30% reduction of the total cutting time.

For the deepest cuts (> 20cm), it is recommended to make the first cutting-steps with a small diameter diamond blade (≤ 450 mm), and then to use a larger diameter diamond blade only for last deepest steps. This procedure preserves the lifespan of the most expensive blade.



> Green concrete sawing methods

Green concrete is cut to control cracking in large concrete floors. The initial sawing of the concrete is done within a 24 hour period at a depth of 1/3 to 1/4 of the total concrete thickness. Generally 300 and 350mm diameter blades are used with 3 or 4mm widths.

After the initial cut has been made, the joint may require additional widening for the backing rod and/or sealant. This requires a blade diameter of 300 or 350mm in widths up to 10mm. This operation requires sometimes 'Bevel' blades with triangular segments to generate a chamfer on the joint edges.





DRILLING Clippy's advice



The performance of any diamond core bit depends heavily on the use of proper drilling techniques. Although drilling conditions and materials may vary, following specific guidelines and safety precautions ensures safe, faster drilling speed and longer bit life.

IMPORTANT:

Always wear proper safety equipment; wear safety glasses, safety footwear, hearing and head protection, and respiratory equipment where required.

> Core Drilling Techniques

Drilling can be made with handheld or fixed equipment.

Handheld drilling has the advantage to require less preparation and is a faster operation, but is recommended for drilling diameters up to 150mm only. Handheld motors safety clutch are designed to protect the end-user against hand-arm injuries and are thus fitted to much less torques than for a fixed drilling operation.

Fixed drilling requires more preparation work to fasten properly the equipment, but then allows much larger drilling diameters with non-limited torques.

You can consult our product selection charts to choose the best tool for each of your requirements.

> Drill rig fastening

Secure the core drill to the work surface so that there is no movement in the drill that would allow the bit to bind in the hole. There are three main fixing methods :

• Dowel fixing

- . Measure and mark clearly both the drilling location and drill rig fastening hole.
- . Select the right type of dowel adapted to the material to drill.
- . Use dowel installation tool with a hammer to ensure the dowel is perfectly tighten into the material.
- . Position the drill rig over the drilling location, using the laser pointer.
- . Tight and adjust the drill rig using the 3 adjusting screws and the spirit-level.

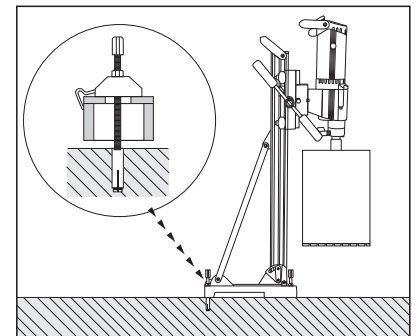

• Vacuum fixing

CAUTION : vacuum fixing requires a solid and flat surface to ensure the best safety for the operators. Make sure the surface won't break or detached under the weight of the drilling equipment.

- . Measure and mark clearly the drilling location.
- . Position the vacuum base and plug it to the vacuum pump. Ensure the vacuum purge tap is closed.
- . If required, add some weight or pressure above the vacuum base to help generating the vacuum.
- . Fix the threaded rod to the vacuum base and position the drill rig over the drilling location, using the laser pointer.
- . Tight and adjust the drill rig using the 3 adjusting screws and the spirit-level.

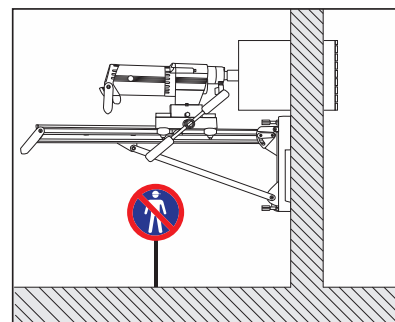
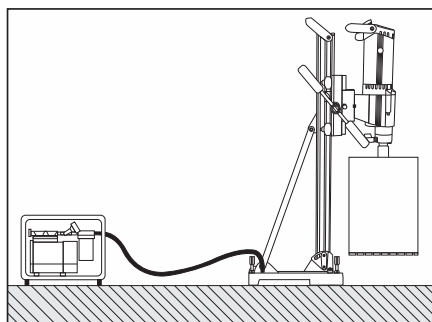

DRILLING Clippy's advice



• Brace fixing

CAUTION : brace fixing requires a solid surface on both ends of the brace to ensure the best safety for the operators. Make sure the surface won't break or detach under the strength of the brace tightening.

- . Measure and mark clearly the drilling location.
- . Position the drill rig and fix it with the brace. You can position the telescopic brace either on the top of the column or directly on the drilling base.
- . Tight and adjust the drill rig using the 3 adjusting screws and the spirit-level.

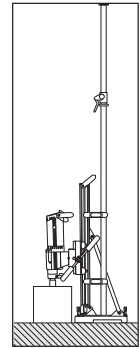

> Core Drilling Operation

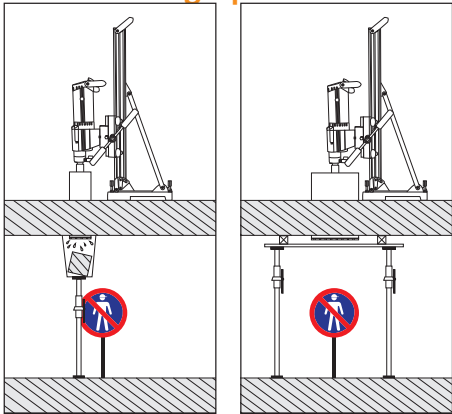

- . Mount the drilling motor on the rig.
- . Use a quick-release ring between the motor and corebit to prevent blockage after work.
- . Set the proper rotation speed depending on the drilling diameter.
- . Plug to water supply and set a sufficient supply of water to ensure that hole will be constantly flushed of abrasive slurries.
- . Plug the three-pronged plug (PRCD) on the power cord of the motor into a grounded electrical outlet of the appropriate voltage.
- . Slowly lower the bit into the cut so that there is no skidding or lateral movement of the drill bit. The entire circumference of the core bit should penetrate the drilling surface before additional pressure is applied to the handle.
- . Exert steady downward pressure on the bit while drilling. Do not force the bit into the material.
- . Do not stop the flow of water or the rotation of the bit as long as the bit is in the hole. If the drilling rate decreases noticeably, check the core bit. The slower penetration rate generally means that the bit is dull and needs to be reconditioned.

In most cases, core drilling requires the use of water. Properly ground the core drill, as the use of any electrical tools in wet areas can be hazardous.

The core drill must be securely fastened to the intended work surface (wall, deck, etc.), using anchor bolts, vacuum pad or jack screw. Use extreme caution when drilling through floors. Check for electrical conduit.

Provide protection for all personnel and materials below the areas being drilled.

> Optimal RPM for diamond core bits

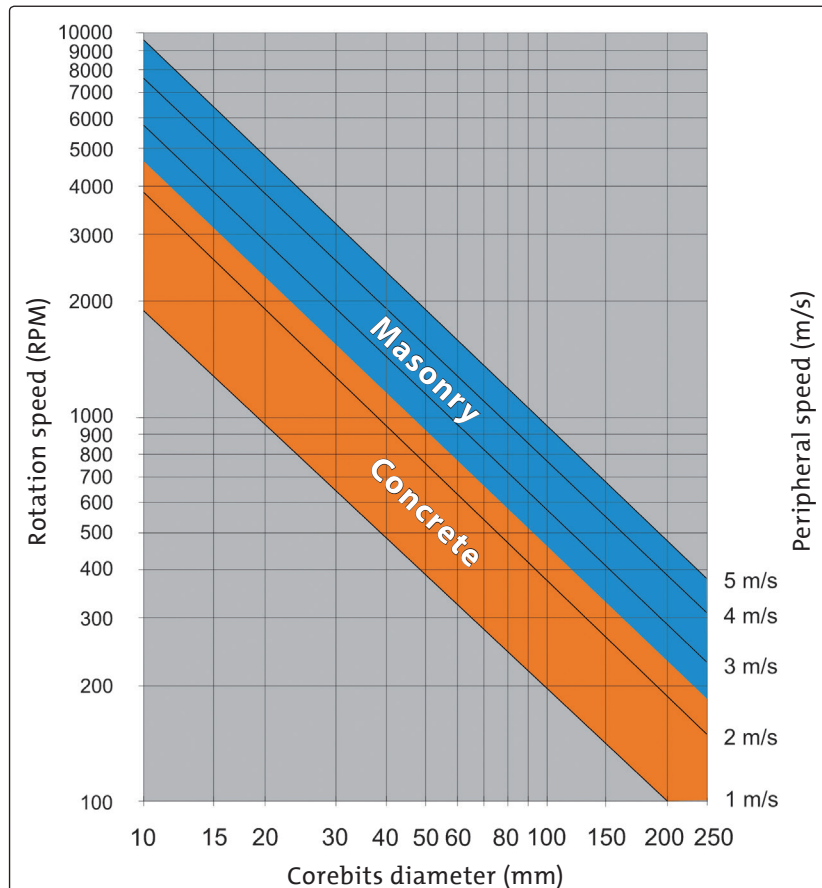



SAFETY RECOMMENDATIONS FOR THE USE OF DIAMOND TOOLS

	DO'S	DON'TS
1	<p>Ensure the saw bears the mark EN 13236</p>	<p>Do not use a saw without EN 13236 mark</p>
2	<p>Always read the safety instructions</p>	<p>Don't throw away the instructions before reading</p>
3	<p>Examine the saw for damage</p>	<p>Never use damaged saws</p>
4	<p>Align flanges correctly</p>	<p>Flanges incorrectly aligned</p>
	<p>Observe direction of run</p>	<p>Incorrect bore size - No direction of run</p>
5	<p>Ensure the guard is fitted</p>	<p>Never remove the guard</p>

	DO'S	DON'TS
6	<p>Ensure work piece is secure</p>	<p>Never cut an unstable work piece</p>
7	<p>Use protective equipment</p>	<p>Never cut without protective equipment</p>
8	<p>Only use for cutting off</p>	<p>Do not grind with a diamond saw</p>
9	<p>Always straight cutting</p>	<p>Never twist in the cut</p>
10	<p>Let the saw cut freely</p>	<p>Never force the cut</p>

THE BLADE & MACHINE MARKING SYSTEMS

Product Name

Wet or Dry cutting

Know what the blade is designed for
For dry cutting (☀️)
For wet cutting (💧)

Laser Welded Logo

Laser welded segments
guarantee maximum
safety during use.

European Standards

Conforms to standard EN 13236 and
Founder Member of oSa
(Organisation for the Safety of Abrasives).

Material Pictogram

To know clearly what type of materials
the blade can cut.

Stars Pictogram

Indicates the CLIPPER Range of the
blade (see page 174).

Diameter and Bore (hole) size

Ensure the sizes are correct for
your machine.

Bar code

Identification of the blade.

Machine Pictogram

Indicates the type of machine.

Safety and Restrictions of Use

Information of what safety equipment must
be used and restrictions of use.



Laser engraving
(on reverse side) :
permanently marked
product details.

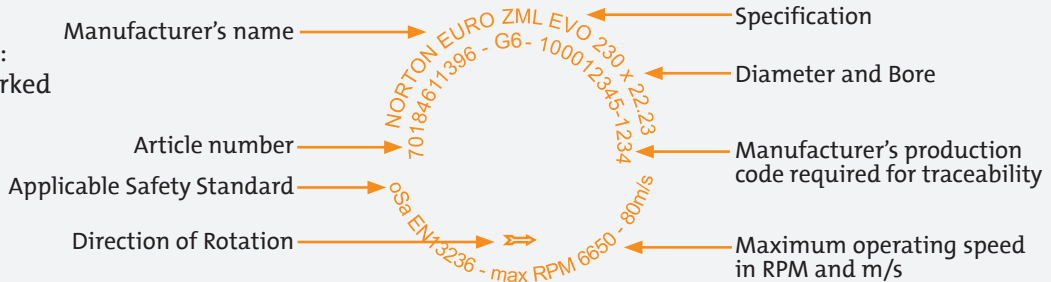

SAFETY & INFORMATION PICTOGRAMS :



Read operator's instructions



Ear protection must be worn



Hand protection must be worn



Eye protection must be worn



Danger : risk of cut



Danger : risk of cut



Never move the machine with the blade running idle



Emergency stop switch



Blade direction of rotation



Do not lift the machine from here



Lift from here

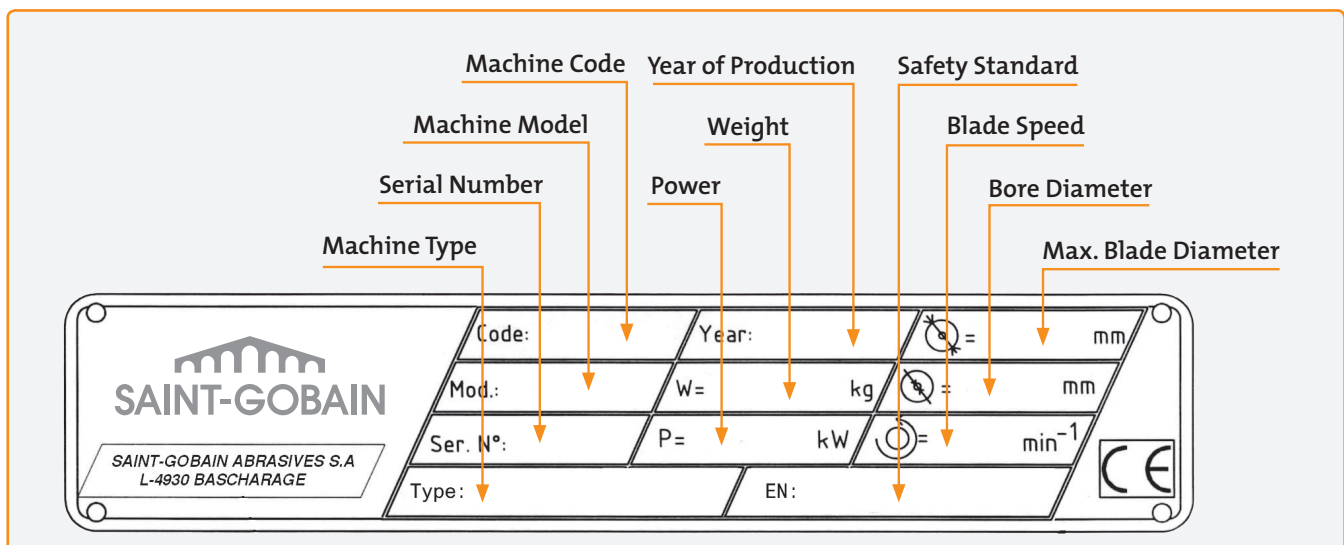







THIN WHEELS Clippy's advice



SHAPE SPECIFICATION SYSTEM

BF 27 	BF 29 	BF 41 	BF 42 
Depressed centre grinding wheels. Available in diameters 76-230mm for hand-held machines	Depressed centre grinding wheels. Available in diameters 115mm & 125mm for hand-held machines	Flat cutting-off wheels. Available in diameters 40-400mm for hand-held machines & 250-400mm for stationery machines	Depressed centre cutting-off wheels. Available in diameters 76-230mm for hand-held machines
Application: grinding	Application: grinding	Application: cutting-off	Application: cutting-off

RECOMMENDED PRACTICE

PORTABLE GRINDERS

GRINDING Rough Work

- Do not use a cutting-off wheel for snagging
- Do not work with the side of a wheel, you will cut the reinforcing cloths
- Work at an angle of 10 to 30° with a longitudinal action

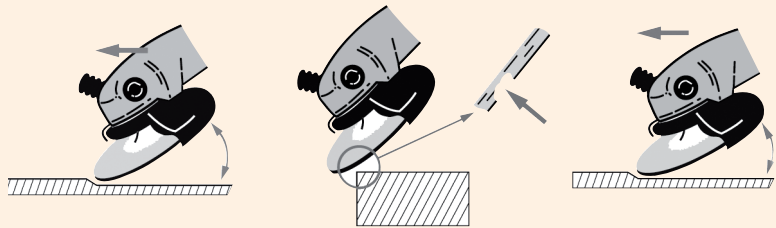

GRINDING Finishing Work

- Angle of work 15°
- Rotary action



CUTTING-OFF

- Arrange the workpiece so that a uniform section can be cut

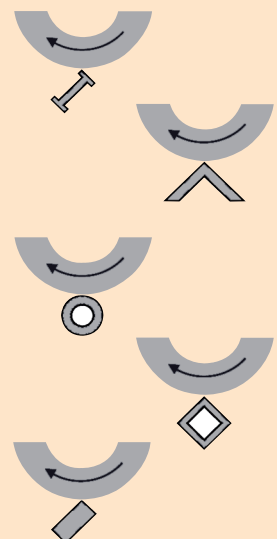
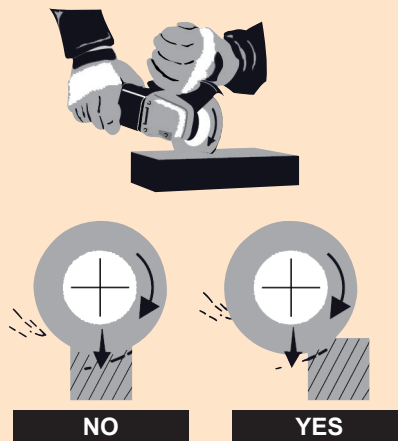
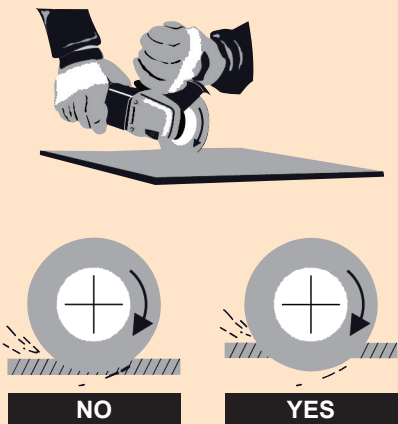



THIN WHEELS Clippy's advice



FIXED MACHINE

DOWNSTROKE HEADS

- Lay out the shape parts in order to have a constant section
- Avoid any wedging of the grinding wheel
- Make sure the wheel is cleared

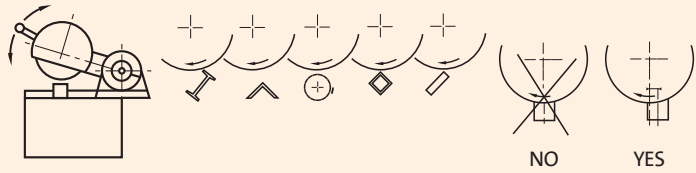

AUTOMATIC FEED

- In the case of thick parts, use the reciprocating motion of the carriage

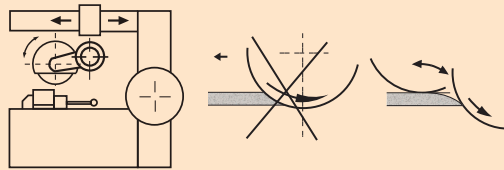

OSCILLATING HEADS

OPERATING MODE

- 1 – Oscillating
- 2 – Cutting-off

- Do not use this type of machine with a downstroke action

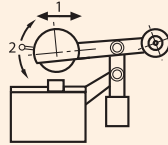



SAFETY : THE NUMBER 1 PRIORITY FOR NORTON

Diamond Tools & Thin Wheels

Users of diamond tools and abrasives should be aware that these products rotate at extremely high speeds for efficient operation. Care must therefore be taken in order not to abuse these tools. The risk of product failure is increased with low quality products that are not designed and manufactured to conform to the respective standards and regulations in place. Such non-conforming products may not withstand mechanical loads and heat generated during use.

EN13236 > EN13236 - Standards for Diamond tools

 The European Standard EN13236 governs the safety requirements for super abrasive (diamond) products. User safety has always been NORTON's top priority. NORTON and Saint-Gobain Abrasives have taken an active role in the compilation of this safety standard, through the FEPA, the Federation of European Producers of Abrasives.

EN12413 > EN12413 - Standards for Thin Wheels abrasives (cutting and grinding discs)

 This standard highlights that these types of cutting and grinding discs have a use by date. This "use by" date must be permanently marked into the central metal rim of every disc.



> oSa

In 2000, NORTON and Saint-Gobain Abrasives was one of the founding members of the Organisation for Safety of Abrasives (oSa). All member companies of oSa have to implement strict manufacturing, safety and quality standards that comply with the requirements of EN13236 and EN12413, and are regularly audited to ensure conformity. The oSa symbol displayed on an abrasive or diamond product is a further guarantee to the user of product safety and quality.

OPERATING SPEEDS

MAXIMUM OPERATING SPEED		
Diameter	Max. m/s	Max. RPM
Ø 100mm	80	15300
Ø 115mm	80	13300
Ø 125mm	80	12250
Ø 150mm	80	10200
Ø 180mm	80	8500
Ø 200mm	80	7650
Ø 230mm	80	6650
Ø 250mm	100	7650
Ø 300mm	100	6400
Ø 350mm	100	5500

Machines

Our philosophy concerning design and manufacturing of NORTON CLIPPER machines is aligned with diamond tools and abrasives approach.

We provide operating devices which will both comply with safety standards and ensure high level of performance even in extremely difficult conditions.

Of course our machines comply with the following European Directives:

> European Directive 2006/42/EC on machinery

This Directive provides the regulatory basis for the harmonisation of the essential health and safety requirements for machinery at European Union level. It guarantees a high level of protection to EU workers and citizens.

> Low Voltage Directive 2006/95/EC

Part of our products range includes electrical motors, and our design complies with Low Voltage European directives. As for all directives, we even do more than requested to provide our customers highly reliable and safe working conditions.

> Electromagnetic Compatibility Directive 2004/108/EC

In the construction business, CLIPPER machines are used in many places, close to either professional or domestic equipments which can be sensitive to electromagnetic disturbances. We take this risk into account and can ensure that our design complies with Electromagnetic Compatibility European Directive.

Saint Gobain Abrasives is actively involved in the elaboration of specific Safety Regulations and Standards like type C harmonized European standards issued from the European Directive 2006/42/EC on machinery :

EN 12418 Masonry and stone cutting-off machines for job site – Safety

EN 13862 Floor cutting-off machines – Safety

EN 12348 Core drilling machines on stand – Safety

EN 15027 Transportable wall saw and wire saw equipment for job site – Safety

EN 12649 Concrete compactors and smoothing machines – Safety

EN 19432 Portable, hand-held, internal combustion engine driven cut-off machines

In addition to regulations and formal aspects, our engineers have a strong understanding of customers' applications in the field. They work together with our Customer Service to consider or even anticipate potential risks and design the safest way.



NORTON certifies that all diamond products fully comply with the requirements of EN13236 and the requirements of oSa.

NORTON certifies that all their abrasive cutting and grinding discs fully comply with the requirements of EN12413.

NORTON strongly advises users not to use products that do not carry the symbols of EN13236, EN12413, FEPA or oSa.



AFTER-SALE

- By choosing CLIPPER machines, diamond blades or core bits, you are choosing quality products designed for professional users. All machines and related accessories are guaranteed for one year (excluding normal wear).
- All CLIPPER products quality criteria are checked during manufacturing process. If, despite quality checks, during the first year following purchase, any fault arises due to a hidden defect or a manufacturing fault, your CLIPPER machine must be returned complete to the sales outlet where you purchased it, together with your invoice or sales receipt.
- After testing with its accessories by the sales outlet's after-sales service, the machine can be shipped for repair to your nearest CLIPPER after-sales service or to the CLIPPER after-sales service European Center at the following address:

SAINT-GOBAIN ABRASIVES
190, Bd JF Kennedy
L-4930 Bascharage
GD LUXEMBOURG
Tel : +352 50401 1 - Fax : +352 501633

- In order to optimise repair efficiency, a detailed description of machine issue will be highly appreciated. A standard CLIPPER Repair Form is available on www.construction.norton.eu.
- In case of an internal combustion motor issue, motor manufacturer or its local dealer can be directly contacted, which will save time.
- If the warranty applies, the CLIPPER after-sales service will return at its own expense the repaired and tested machine to the sales outlet. In case warranty doesn't apply due to incorrect use of the machine, a quotation for repair will be sent for approval before repair.
- The repaired machine will be guaranteed for the time remaining until expiry of the original guarantee.

SAINT-GOBAIN ABRASIFS S.A.
B.P. 8 - Rue de l'Ambassadeur
78 702 CONFLANS CEDEX
FRANCE
Tel : +33 (0)1 34 90 40 17
Fax : +33 (0)1 39 19 76 24
sales.nlx@saint-gobain.com

SAINT-GOBAIN ABRASIVES BV
Groenloseweg 28
7151 HW Eibergen
P.O. Box 10
7150 AA EIBERGEN
THE NETHERLANDS
Tel : +31 545 466466
Fax : +31 545 474605

SAINT-GOBAIN ABRASIVES NV/SA
Industrielaan 129
1070 Anderlecht /Brussel
BELGIUM
Tel : +32 (0)2 267 21 00
Fax : +32 (0)2 267 84 24

SAINT-GOBAIN ABRASIFS
LOB 17 - Office 404 / 405
Jebel Ali Free Zone Area
PO BOX 18260 - DUBAI
UNITED ARAB EMIRATES
Tel : +971 4 88 17 836
Fax : +971 4 88 73 210
abrasives-emea@saint-gobain.com

SAINT-GOBAIN ABRASIFS, S.A.
2 allée des Figuiers
Ain Sebaâ - CASABLANCA
MOROCCO
Tel : +212 5 22 66 57 31
Fax : +212 5 22 35 09 65
salesmaroc@saint-gobain.com
www.norton.eu

SAINT-GOBAIN ABRASIVES Russia
105082, РОССИЯ, Москва,
Ул. Фридриха Энгельса, д. 58,
строение 2, 2-й этаж
Телефон: +7 495 220 07 45
+7 495 937 32 23
Факс: +7 495 937 32 24 / 17

SAINT-GOBAIN ABRASIVES Kft.
Bányalég u.60/B.
1225 Budapest
HUNGARY
Tel : +36 1 371 2250
Fax : +36 1 371 2255
nortonbp@axelero.hu
www.norton.eu

SAINT-GOBAIN ABRASIVES, S.R.O.
Poernická 272/96, Malešice
108 00 Praha 10
CZECH REPUBLIC
Tel : +420 255 719 326
Fax : +420 255 719 321
info@sgabrasives.cz
www.sgabrasives.cz

SAINT-GOBAIN HPM POLSKA Sp. z o.o.
UL. NORTON 1
62-600 KOŁO
POLAND
Tel : +48-63-261 75 36
Fax : +48-63-272-0401

SAINT-GOBAIN GLASS
Business Unit Abrasivi
Punct de Lucru: loc.Vetis, jud.
Satu Mare 447355
str. Careiului 11
Parc Industrial Renovatio
ROMANIA
Tel : 0040-261-839.709
Fax : 0040-261-839.710



TROUBLESHOOTING DIAMOND PRODUCTS

BLADE WORN OUT-OF-ROUND

Worn out shaft bearings on saw.	Install new blade shaft bearings.
Machine spindle worn out. A groove may have been scored on the spindle as a result of previous blade spinning on the spindle.	Replace worn out spindle.
Blade slipping on spindle.	Tighten spindle nut on the machine. Make certain the drive pin is fitted and functioning where required.
Bond too hard for material causing blade to “pound”.	Use proper blade specification, a softer bond blade maybe required.
Blade being pushed to hard and not allowed to cut – causes bouncing and will lead to blade going out of round.	Slow down traverse rate or reduce depth of cut.
Blade spindle speed to high – causing polishing and causing blade to act hard and bounce.	Reduce spindle speed to recommended RPM.

UNEVEN SEGMENT WEAR

Insufficient water flow, generally on one side of the blade, which reduces side clearance.	Check pipes are clean and correctly positioned . Make certain that adequate clean water is being equally distributed to both sides of the blade.
Equipment defect, which causes the blade to wear out of round.	Replace bad bearings, worn out machine spindle or realign spindle. On concrete saws, ensure the engine runs smoothly, to prevent harmonic vibrations, which in turn cause the blade to pound on a regular cycle basis.
Saw head misaligned.	Check saw head alignment both vertically and horizontally.

PREMATURE WEAR OF STEEL CENTRE

Steel centre wears away faster than the diamond segment.	If material cut is very abrasive, a blade with undercutting protecting segments should be used.
Highly abrasive particles are being generated during cutting.	Use sufficient water to flush swarf out of cut.
<ol style="list-style-type: none"> 1. Hammer segment. 2. Double height segment. 3. Slant segment. 	Caution: Wear-retardant cores are not always the final answer to eliminate undercutting. Blades should be inspected periodically during use.

STEEL CENTRE LOSS OF TENSION

Blade core has been overheated .	Provide proper amount of water to both sides of the blade. Make sure water pump is producing sufficient water, that no blockage occurs in water lines, and pipes are correctly positioned.
Blade core has been overheated as a result of blade spinning on spindle.	Check spindle and arbor hole for damage. Tighten spindle nut and make certain that the drive pin is present and functioning on floor saws.
Blade core has been overheated because of blade core rubbing side of material being cut.	Properly align machine to allow straight cutting. Avoid twisting the blade in cut. Maintain a strong grip on saw. Make certain that spindle RPM is correct so that blade operates at its recommended speed.
Unequal pressure on flanges.	Flanges should be of identical and the correct diameter and cleaned regularly.
Machine spindle RPM does not match recommended blade RPM.	If spindle speed is to high blade will act hard and overheat, use correct spindle speed for blade diameter.

BLADE IS WOBBLING

Blade mounted on a damaged or worn machine.	Check for damaged or worn out bearings, bent or worn out blade spindle. Also check flanges to make sure they are clean, flat, and of the manufacturer’s recommended diameter.
Blade being run at improper operating speed (RPM).	Make sure that the spindle is turning at the proper RPM to match the recommended speed for the diameter of blade. Use a tachometer to make certain the machine spindle is set at the proper operating speed.
Blade bent.	Do not use, contact manufacturer.

ARBOR HOLE OUT-OF-ROUND

Blade flanges are not properly tightened, causing blade to rotate or vibrate on spindle.	Tighten spindle nut and make certain blade is adequately secured to prevent rotation on spindle.
Worn out, bent or dirty flanges which do not allow proper blade clamping.	Clean or replace flanges, make sure they are not worn out, and tighten spindle nut properly.
Blade not properly mounted.	Ensure that the blade is mounted on the proper diameter of spindle.

SHORT BLADE LIFE

Using the wrong blade on a specific material.	Use the proper blade specification, as recommended by the manufacturer, depending on your machine power and the hardness and type of material cut.
Worn blade shaft bearings, worn blade arbor or misaligned machine spindle.	Replace defective parts.
Loss of power, resulting from loose or damaged drive belts.	Tighten or replace drive belts.
Inadequate water flow to the blade.	Make sure water hoses are clean and free from any blockages. Ensure clean and correct water flow based on the blade diameter.
Power of the machine is too high for the specification.	Refer to the application chart to define the proper specification and bond hardness to be used based on the power of your saw.
Machine spindle speed too low for blade diameter.	Use correct speed/set up for blade diameter or use a larger blade.

BLADE WILL NOT CUT

Blade is too hard for the material being cut (improper blade specification).	Refer to blade application chart for the proper blade specification based on the machine power and type and hardness of the aggregate.
Blade has glazed over, probably as a result of being used on a too hard material or cutting too deep in one pass.	Sharpen the blade by cutting softer abrasive material to expose diamonds. If continual sharpening is required, this would indicate that the blade specification is too hard for the material being cut.
Blade rotation speed too high.	Use the correct spindle speed (RPM) for the diameter of blade.
Cutting too deep in one pass.	Cutting in multiple passes is often required.
Allow the diamond to do the work.	Pushing the diamond tool too hard will cause the diamond to polish and stop working.

SEGMENT LOSS

The material and/or saw was not held firmly, which caused the blade to twist or jam in the cut.	Hold material or saw firmly.
Not sawing in a straight line with overcorrecting caused the blade to twist or jam in the cut.	Properly align saw to allow straight cutting, avoid twisting the blade in the cut.
Defective flanges which cause the blade to flutter in the cut or fail to properly support the blade in perfect alignment.	Clean foreign material from flange surfaces, or replace flanges if they are under manufacturer's recommended diameter or are bent or deformed.
Blade is too hard for material being cut causing the segment to glaze over. The segment separated due to impacts or fatigue.	Use the proper blade specification for the material being cut.
Overheating due to inadequate supply of coolant (water or air). This usually comes with discolorations on the core in the area of segment loss. Overheating of blades may cause core cracks or segment loss.	Wet cutting – provide adequate water flow on both sides of the blade. Dry cutting – periodically allow blades to run out of the cut. The blade will cool in a few seconds so that sawing may continue.
Under cutting on steel centre.	Segments suffer undercutting from abrasive material or inadequate water supply. Use undercutting protection or increase water flow. If in doubt return blade for inspection.
Power of the machine is too high for the specification.	Refer to the application chart to define the proper specification to be used based on the power of your saw.

CRACKS IN SEGMENT

Blade is too hard for material being cut.	Use blade with softer bond.
-------------------------------------------	-----------------------------

